



HANDBOOK

Net-Log

Audio Logger



Manufacturers of audio & video
products for radio & TV broadcasters

SONIFEX

For the latest Sonifex handbook information please visit the
Sonifex website at www.sonifex.co.uk

This handbook is for use with the following product:

Net-Log Audio Logger

Stock Code: 30-136

Revision 3.01 February 2020

©Sonifex Ltd, 2020

All Rights Reserved

Sonifex Ltd, 61, Station Road, Irthlingborough,
Northants, NN9 5QE, England.

Tel: +44 (0)1933 650 700

Fax: +44 (0)1933 650 726

Email: sales@sonifex.co.uk

Website: <https://www.sonifex.co.uk>

Information in this document is subject to change without notice and does not represent a commitment on the part of the vendor. Sonifex Ltd shall not be liable for any loss or damage whatsoever arising from the use of information or any error contained in this manual.

No part of this manual may be reproduced or transmitted in any form or by any means, electronic or mechanical, including photocopying, recording, information storage and retrieval systems, for any purpose other than the purchaser's personal use, without the express written permission of Sonifex Ltd. Unless otherwise noted, all names of companies, products and persons contained herein are part of a completely fictitious adaptation and are designed solely to document the use of Sonifex product.

Made in the UK by **SONIFEX**

Contents

Product Warranty - 2 Year Extended	i	Maximum Network Connections	9
Sonifex Warranty & Liability Terms & Conditions	i	Connecting Net-Log To Your Network	10
1. Definitions	i	IP Addresses	10
2. Warranty	i	Subnet Masks	11
Unpacking Your Product	ii	Installing Net-Log-Win Software	11
Repairs & Returns	iii	Entering Network Settings	11
☞ Conformity	iii	4. Startup & Login	16
Safety & Installation of Mains Operated Equipment	iii	Starting Net-Log-Win	16
Voltage Setting Checks	iii	Maximum Concurrent Users	16
Fuse Rating	iii	Multiple Net-Logs On A Network	16
Power Cable & Connection	iii	Licensing Your Net-Log	16
WEEE Directive	iv	Obtaining License Codes	16
Atmosphere/Environment	iv	The Login Procedure	17
1. Introduction	1	The Device List Editor	17
General Overview	1	First Time Use of Net-Log	18
The Net-Log	1	Changing User Details	18
Net-Log Control Software	2	General Screen Layout	19
Recording	2	Disconnect/Log-Off Button	20
Playing	2	Net-Log Selector	20
Archiving	2	Alarm Indicators	20
Network	3	Network Activity Indicators	20
Required Hardware	4	Net-Log & PC Time	20
2. Net-Log Hardware	5	Status Bar	20
Physical Description	5	Screen Selection Buttons	20
Power	5	Mentor Status Indicator	20
Level Indicators	5	5. Recording	21
Record Control/Indicator	6	The Record Screen	21
Archive Alarm	6	Manual Recording	21
Disk Drive Alarm	6	Program Recording	21
Reset Switch	6	Auto Recording	21
Audio Inputs/Input Level Control	7	Remote Recording	21
Network Status Indicators	7	Serial Recording	21
Network Connections	7	Manual Recording	22
RS232 Serial Ports	7	Program Recording	22
Alarm Outputs And Remote Inputs And Outputs	7	Saving and Loading Record Programs	23
3. Set-up & Installation	8	Auto Recording	23
Adjusting Record Input Levels	8	Remote Recording	24
Network Topology	8	Serial Recording	24
		Record Tally Outputs	24

6. Playing & Downloading	25		
Track List Display	25		
Play Download	25		
Play Program	26		
Play Stream	27		
Play File	28		
7. Archiving	30		
The Archiving Process	30		
Configuring Archival To A Networked PC	30		
Alarm Enabled	30		
Buffer Size	31		
Warn Time	31		
Arrange Archive Audio into Fixed Duration Files	31		
Target File Duration	31		
File Type	31		
Destination IP Address	31		
Target Folder Share Name	31		
Auto Purge on Record Stop Enabled	31		
Format of Archived Files	31		
Beginning to Archive	32		
8. Serial Control Interface	33		
Televic CE2500 Interface	33		
Disabled	34		
Single Mic	34		
Mic Range	34		
Televic CE2500 Protocol	35		
System Synchronisation	36		
President Microphone Activation	36		
President Microphone Deactivation	36		
Delegate Microphone Activation	36		
Delegate Microphone Deactivation	36		
Deactivate All Microphones	36		
System Reset (Deactivate All Microphones)	36		
AMX/Crestron Interface	37		
AMX/Crestron Protocol	37		
Speed of Commands & Responses:	37		
Record Start Command	38		
Record Stop Command	38		
Status Command	38		
		Time Command	38
		Date Command	38
		Reply Error Codes	38
		9. Options	39
		Saving and Loading Options	39
		Record Options	39
		Disable	39
		Override Enabled	39
		Format	39
		Mode	40
		Channels	40
		Sample Rate & Bit Rate	40
		Start Level	40
		Start Duration	40
		Stop Level	40
		Stop Duration	40
		Service Names	40
		Record Capacity	40
		Archive Options	40
		Alarm Enabled	41
		Buffer Size (Mbytes)	41
		Warn time prior to data loss	41
		Arrange Archive Audio into Fixed Duration Files	41
		Target File Duration (mins)	41
		Target File Type	41
		Destination IP Address	41
		Target Folder Share Name	41
		Auto Purge on Record Stop Enabled	41
		Archive Auto Continue Enabled	41
		Play Options	41
		Use Defaults	42
		Default Play Screen	42
		Play Download Defaults:	42
		Select Audio By Cut and Generate File Name From Cut Details	42
		Folder	42
		File Type and Bit Rate	42
		Play Program Defaults:	42
		Auto Create Program Name and Download Separate Cut	
		For Selected Days	42

Folder	42	Suspend Play Programs	51
File Type and Bit Rate	42	Log Play Program Operation	51
Play Stream Defaults:	42	Deleting Cuts	51
Ignore cut end time selection	42	View	51
Play File Defaults:	42	Net-Log Connections	51
Folder	42	Net-Log Status	52
Remotes Options	42	Drive Alarm	52
Disabled	43	Cut Change	52
Momentary	43	Program Change	52
Latching	43	Config Change	52
Normally Off, Switched On For Alarm Condition	43	Record Auto Enabled	52
Clock Source Options	43	Record Active	52
Control Options	44	Archive Enabled	52
No Control/Interface Selected	44	Archive Pending	52
Televic CE2500	44	Archive Auto Purge	52
AMX/Crestron	44	Archive Active	52
Net-Log-Win Options	44	Archive Warn	52
Info Font	45	Archive Alarm	52
User Font	45	Network Stats	53
Information	45	Audio Header Info	53
10.The Administrator	46	Play Program Log	54
Licenses	46	About Sonifex Net-Log	54
Accounts Editor	46	12.Auto-Archive	55
“admin”	46	Introduction	55
“user1” to “user25”	46	Licensing	55
“guest”	46	The Net-Log List	55
Function Access – View	47	The Status Bar	55
Function Access – Control	47	Performance	56
User Name & Password	47	System Set-up	56
The Onboard Clock	48	Starting The Archive	56
Updating The Onboard Clock	48	The Settings Screen	56
Network Settings	48	Device List	56
Updating Firmware	49	System Name	57
Resetting The Net-Log	50	Force Record Stop at Midnight	58
11.Tools	51	Auto-Delete Archives	58
Show Cut List	51	Use mm-dd-yyyy Format for Archive Folders	58
Auto Refresh Cut Display	51	E-Mail	58
Play Cut Auto Load	51	The Status Screen	58
Hide Unavailable Cuts	51	The Control Screen	59

The Archive Screen	59
The Event Log Screen	60
Reports	60
Status Report	60
Error Report	61
Possible Errors	61
Archive Warn Report	61
Archive Alarm Report	61
Startup/ Shutdown	61
The Schedule	61
The Schedule Database	61
Network Scheduling	61
The Schedule Screen	62
13.Net-Log Scheduler	64
Introduction	64
Database Connection Status	64
Primary and Backup Schedules	64
Database Locations	65
Create a New Event	66
Refreshing the Schedules	67
14.Technical Specification	68
MP2 Record Data Rates	69
MP3 Data Rates Supported For Play Download	69
Pin Connections	69
15.Glossary	72

Figures

Fig 1-1: Net-Log System Block Diagram	1
Fig 1-2: Single Net-Log Connection example	2
Fig 1-3: Multiple Net-Log Connection example	3
Fig 2-1: The Front Panel	5
Fig 2-2: The Rear Panel	6
Fig 3-1: Network Topology	8
Fig 3-2: Maximum Simultaneous Streams.	9
Fig 3-3: IP Addresses	10
Fig 3-4 : Net-Log-Win Installation	11
Fig 3-5: Net-Log-Win Serial Utility	12
Fig 3-6: Detail of Net-Log-Win Serial Utility	12
Fig 3-7: Diagram of a Null Modem Cable	13
Fig 3-8: Diagram of 'straight through' and 'crossover' CATS cables	13
Fig 3-9: Details of Net-Util Tool buttons	14
Fig 4-1: The Initialisation Screen	16
Fig 4-2: The Licensing Screen	17
Fig 4-3: The Login Screen	17
Fig 4-4: The Net-Log Device List Editor	18
Fig 4-5: User Details	19
Fig 4-6 General Screen Layout	20
Fig 5-1: Manual Record Screen	21
Fig 5-2: Program Record Screen	22
Fig 5-3: Program Record Popup Menu Commands	23
Fig 5-4: Auto Record Mode	24
Fig 6-1: Play Download Screen	25
Fig 6-2: Play Program Screen	26
Fig 6-3: Play Stream Screen	28
Fig 6-4: Minimum Play Stream Delays	28
Fig 6-5: Play File Screen	29

Fig 7-1: Archive Options Screen	30	Fig 12-4: The Settings Screen	57
Fig 7-2: Archive Screen.	32	Fig 12-5: The Settings Screen	58
Fig 8-1: Control Options Screen	33	Fig 12-6: The Status Screen	59
Fig 8-2: Televic CE2500 Interface Options	34	Fig 12-7: The Control Screen	59
Fig 9-1: Record Options	39	Fig 12-8: The Archive Screen	60
Fig 9-2: Archive Options	41	Fig 12-9: The Event Log Screen	60
Fig 9-3: Play Options	42	Fig 12-10: Sharing and Security Selection	62
Fig 9-4: Record Remotes Options	43	Fig 12-11: Schedule Properties Screen	62
Fig 9-5: Clock Source Options	43	Fig 12-12: Permissions Screen	62
Fig 9-6: Control Interface Options	44	Fig 12-13: D:Scribe Dongle	62
Fig 9-7: Televic CE2500 Control Options	44	Fig 12-14: Primary Archive Screen	63
Fig 9-8: Net-Log-Win Options	45	Fig 13-1: Net-Log Scheduler's Listing	64
Fig 9-9: Info Options	45	Fig 13-2: Block diagram showing two mirrored systems for use as primary and backup	65
Fig 10-1: Net-Log Administrator Menu	46	Fig 13-3: Selecting Database Locations	65
Fig 10-2: Accounts Editor	46	Fig 13-4: Entering a New Schedule Recording	66
Fig 10-3: Function View	47	Fig 13-5: Updated Listings with a New Recording	66
Fig 10-4: Function Control	47	Fig 13-6: A Schedule List Showing Multiple Recordings	67
Fig 10-5: Select or Edit User Name & Password	47		
Fig 10-6: Network Settings	49		
Fig 10-7: Upgrading Firmware	49		
Fig 11-1: Net-Log Tools Menu.	51		
Fig 11-2: Net-Log Connections Screen	52		
Fig 11-3: Net-Log Status Screen	53		
Fig 11-4: Net-Log Stats Screen	53		
Fig 11-5: Net-Log Audio Header Info Screen	53		
Fig 11-6: Play Program Log Screen	54		
Fig 11-7: Net-Log About Screen	54		
Fig 12-1: The Status Screen	55		
Fig 12-2: The Net-Log List	55		
Fig 12-3: Net-Log Device List	57		

SONIFEX

Register Online for an Extended 2 Year Warranty

As standard, Sonifex products are supplied with a 1 year back to base warranty.

If you register the product online, you can increase your product warranty to 2 years and we can also keep you informed of any product design improvements or modifications.

Product: _____

Serial No: _____

To register your product, please go online to www.sonifex.co.uk/register

Product Warranty - 2 Year Extended

As standard, Sonifex products are supplied with a 1 year back to base warranty. In order to register the date of purchase and so that we can keep you informed of any product design improvements or modifications, it is important to complete the warranty registration online. Additionally, if you register the product on the Sonifex website, you can increase your product warranty to 2 years. Go to the Sonifex website at: <http://www.sonifex.co.uk/technical/register/index.asp> to apply for your 2 year warranty.

Note: For your own records the product serial number is recorded on the CE certification page of this handbook.

Sonifex Warranty & Liability Terms & Conditions

1. Definitions

‘the Company’ means Sonifex Ltd and where relevant includes companies within the same group of companies as Sonifex Limited.

‘the Goods’ means the goods or any part thereof supplied by the Company and where relevant includes: work carried out by the Company on items supplied by the Purchaser; services supplied by the Company; and software supplied by the Company.

‘the Purchaser’ means the person or organisation who buys or has agreed to buy the Goods.

‘the Price’ means the Price of the Goods and any other charges incurred by the Company in the supply of the Goods.

‘the Warranty Term’ is the length of the product warranty which is usually 12 months from the date of despatch; except when the product has been registered at the Sonifex website when the Warranty Term is 24 months from the date of despatch.

‘the Contract’ means the quotation, these Conditions of Sale and any other document incorporated in a contract between the Company and the Purchaser.

This is the entire Contract between the parties relating to the subject matter hereof and may not be changed or terminated except in writing in accordance with the provisions of this Contract. A reference to the consent, acknowledgement, authority or agreement of the Company means in writing and only by a director of the Company.

2. Warranty

- a. The Company agrees to repair or (at its discretion) replace Goods which are found to be defective (fair wear and tear excepted) and which are returned to the Company within the Warranty Term provided that each of the following are satisfied:
 - i. notification of any defect is given to the Company immediately upon its becoming apparent to the Purchaser;
 - ii. the Goods have only been operated under normal operating conditions and have only been subject to normal use (and in particular the Goods must have been correctly connected and must not have been subject to high voltage or to ionising radiation and must not have been used contrary to the Company’s technical recommendations);
 - iii. the Goods are returned to the Company’s premises at the Purchaser’s expense;
 - iv. any Goods or parts of Goods replaced shall become the property of the Company;
 - v. no work whatsoever (other than normal and proper maintenance) has been carried out to the Goods or any part of the Goods without the Company’s prior written consent;

- vi. the defect has not arisen from a design made, furnished or specified by the Purchaser;
 - vii. the Goods have been assembled or incorporated into other goods only in accordance with any instructions issued by the Company;
 - viii. the defect has not arisen from a design modified by the Purchaser;
 - ix. the defect has not arisen from an item manufactured by a person other than the Company. In respect of any item manufactured by a person other than the Company, the Purchaser shall only be entitled to the benefit of any warranty or guarantee provided by such manufacturer to the Company.
- b. In respect of computer software supplied by the Company the Company does not warrant that the use of the software will be uninterrupted or error free.
- c. The Company accepts liability:
- (i) for death or personal injury to the extent that it results from the negligence of the Company, its employees (whilst in the course of their employment) or its agents (in the course of the agency);
 - (ii) for any breach by the Company of any statutory undertaking as to title, quiet possession and freedom from encumbrance.
- d. Subject to conditions (a) and (c) from the time of despatch of the Goods from the Company's premises the Purchaser shall be responsible for any defect in the Goods or loss, damage, nuisance or interference whatsoever consequential economic or otherwise or wastage of material resulting from or caused by or to the Goods. In particular the Company shall not be liable for any loss of profits or other economic losses. The Company accordingly excludes all liability for the same.
- e. At the request and expense of the Purchaser the Company will test the Goods to ascertain performance levels and provide a report of the results of that test. The report will be accurate at the time of the test, to the best of the belief and knowledge of the Company, and the Company accepts no liability in respect of its accuracy beyond that set out in Condition (a).
- f. Subject to Condition (e) no representation, condition, warranty or other term, express or implied (by statute or otherwise) is given by the Company that the Goods are of any particular quality or standard or will enable the Purchaser to attain any particular performance or result, or will be suitable for any particular purpose or use under specific conditions or will provide any particular capacity, notwithstanding that the requirement for such performance, result or capacity or that such particular purpose or conditions may have been known (or ought to have been known) to the Company, its employees or agents.
- g. (i) To the extent that the Company is held legally liable to the Purchaser for any single breach of contract, tort, representation or other act or default, the Company's liability for the same shall not exceed the price of the Goods.
- (ii) The restriction of liability in Condition (g)(i) shall not apply to any liability accepted by the Seller in Condition (c).
- h. Where the Goods are sold under a consumer transaction (as defined by the Consumer Transactions (Restrictions on Statements) Order 1976) the statutory rights of the Purchaser are not affected by these Conditions of Sale.

Unpacking Your Product

Each product is shipped in protective packaging and should be inspected for damage before use. If there is any transit damage take pictures of the product packaging and notify the carrier immediately with all the relevant

details of the shipment. Packing materials should be kept for inspection and also for if the product needs to be returned.

The product is shipped with the following equipment so please check to ensure that you have all of the items below. If anything is missing, please contact the supplier of your equipment immediately.

Item	Quantity
Product unit	1
IEC mains lead fitted with moulded mains plug	1
Handbook and warranty card	1

If you require a different power lead, please let us know when ordering the product.

Repairs & Returns

Please contact Sonifex or your supplier if you have any problems with your Sonifex product. Email technical.support@sonifex.co.uk for the repair/upgrade/returns procedure, or for support & questions regarding the product operation.

CE Conformity

The products in this manual comply with the essential requirements of the relevant European health, safety and environmental protection legislation.

The technical justification file for this product is available at Sonifex Ltd.

The declaration of conformity can be found at:
<https://www.sonifex.co.uk/declarations>

Safety & Installation of Mains Operated Equipment

There are no user serviceable parts inside the equipment. If you should ever need to look inside the unit, always disconnect the mains supply before removing the equipment covers. The cover is connected to earth by means of the fixing screws. It is essential to maintain this earth/ground connection to ensure a safe operating environment and provide electromagnetic shielding.

Voltage Setting Checks

Ensure that the machine operating voltage is correct for your mains power supply by checking the box in which your product was supplied. The voltage is shown on the box label. The available voltage settings are 115V, or 230V. Please note that all products are either switchable between 115V and 230V, or have a universal power supply.

Fuse Rating





The product is supplied with a single fuse in the live conducting path of the mains power input. For reasons of safety it is important that the correct rating and type of fuse is used. Incorrectly rated fuses could present a possible fire hazard, under equipment fault conditions. The active fuse is fitted on the outside rear panel of the unit.

Power Cable & Connection

An IEC power connector is supplied with the product which has a moulded plug attached.

The mains plug or IEC power connector is used as the disconnect device. The mains plug and IEC power connector shall remain readily operable to disconnect the apparatus in case of a fault or emergency.

The mains lead is automatically configured for the country that the product is being sent to, from one of:

Territory	Voltage	IEC Lead Type	Image
UK & Middle East	230V	UK 3 pin to IEC lead	
Europe	230V	European Schuko round 2 pin to IEC lead	
USA, Canada and South America	115V	3 flat pin to IEC lead	
Australia & New Zealand	230V	Australasian 3 flat pin to IEC lead	

Connect the equipment in accordance with the connection details and before applying power to the unit, check that the machine has the correct operating voltage for your mains power supply.

This apparatus is of a class I construction. It must be connected to a mains socket outlet with a protective earthing connection.

Important note: If there is an earth/ground terminal on the rear panel of the product then it must be connected to Earth.

WEEE Directive



The Waste Electrical and Electronic Equipment (WEEE) Directive was agreed on 13 February 2003, along with the related Directive 2002/95/EC on Restrictions of the use of certain Hazardous Substances in electrical and electronic equipment (RoHS). The Waste Electrical and Electronic Equipment Directive (WEEE) aims to minimise the impacts of electrical and electronic equipment on the environment during their life times and when they become waste. All products manufactured by Sonifex Ltd have the WEEE directive label placed on the case. Sonifex Ltd will be happy to give you information about local organisations that can reprocess the product when it reaches its “end of use”, or alternatively all products that have reached “end of use” can be returned to Sonifex and will be reprocessed correctly free of charge.

Atmosphere/Environment

This apparatus should be installed in an area that is not subject to excessive temperature variation (<0°C, >50°C), moisture, dust or vibration.

This apparatus shall not be exposed to dripping or splashing, and no objects filled with water, such as vases shall be placed on the apparatus.

1. Introduction

General Overview

The principal behind the Net-Log logger is that generally speaking, computers should not be used for recording audio where their general unreliability can cause system crashes or lockups, with little regard for the security of the audio being recorded. However, for playback, using computers is perfectly acceptable and probably preferable, due to the ability to manipulate and edit the audio, provided it is in a suitable format.

The Net-Log

The Net-Log is a 1U rack-mount, hardware audio recorder, designed primarily for audio logging in a broadcast environment. It is able to record up to 4 mono, or 2 stereo audio feeds, which are saved onto a large internal IDE hard disk. The hard disk is continuously over-written, allowing access to all the audio recorded on it. Apart from the front panel mounted record override button, all functions and configurations are controlled via the Ethernet TCP/IP network connection using the supplied Windows control software package.

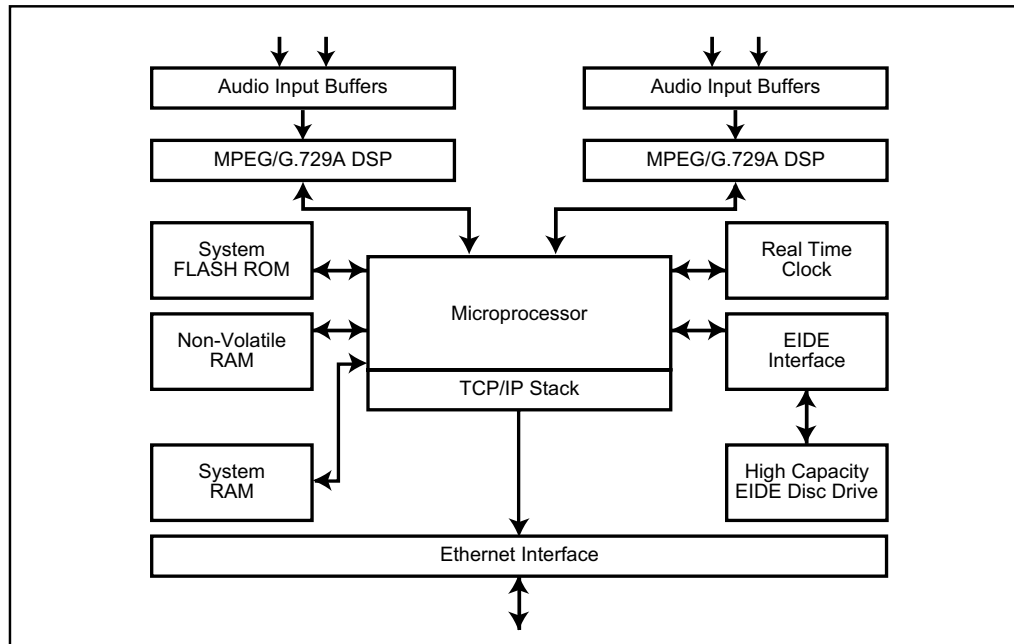

Fig 1-1: Net-Log System Block Diagram

Net-Logs can be used singularly (Fig 1-2), or if more record channels are required, multiple Net-Logs can easily be configured to operate on the same Network (Fig 1-3).

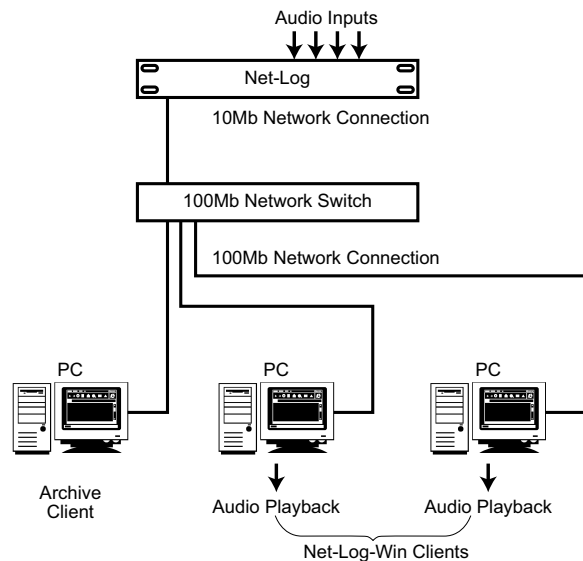

Fig 1-2: Single Net-Log Connection example

Net-Log Control Software

Net-Log works in conjunction with a software control package that runs under Windows. This package consists of Net-Log-Win, Net-Util and Net-Log Auto-Archive. Net-Log-Win is the main control and configuration program. Net-Util is a configuration and monitoring utility that communicates with Net-Log via a serial connection. Net-Log Auto-Archive is a program designed

to Archive audio data from multiple Net-Logs simultaneously.

Recording

Audio presented to the inputs is encoded in one of two user selectable formats, MPEG layer 2 or G.729A (An additional license is required to enable the G.729A format – contact Sonifex Ltd for details). The compressed data is then written to the internal IDE hard disk drive. Recording can be either continuous or programmed to start and stop at selected times. Record set-up allows for mono/dual mono/stereo and sample-frequency/bit-rate selection, depending on record format selected.

When recording has started, these parameters can only be altered once the audio on the disk has been deleted. The hard disk audio cannot be deleted whilst the logger is recording.

Playing

Two methods of audio playback are supported by Net-Log in conjunction with the Net-Log-Win software. Sections of audio can be transferred to a file on the PC using the Play Download function. These files can then be played using Net-Log-Win's media file player. Alternatively, Play Stream offers the ability to play audio direct from the Net-Log.

Archiving

Archive is an automated method of transferring audio data from one or more Net-Logs to a designated PC via the Network interface. When the audio data arrives at the PC, it can be arranged into files of a predetermined size. These files can then be copied to a removable media for long-term storage. If temporary audio storage is required, to satisfy broadcast authority requirements for example, then Archiving may not be necessary as the large hard drives used in Net-Log can, depending on the format or bit rate of the recordings, hold several weeks of audio. Sections of the audio could be downloaded as required using the Play Download function. The Net-Log-Win software provides a simple method of Archiving audio data for users with a single Net-Log. For larger installations where multiple Net-Logs

are used, the Net-Log Auto-Archive package offers the ability to archive audio data from up to 20 Net-Logs simultaneously.

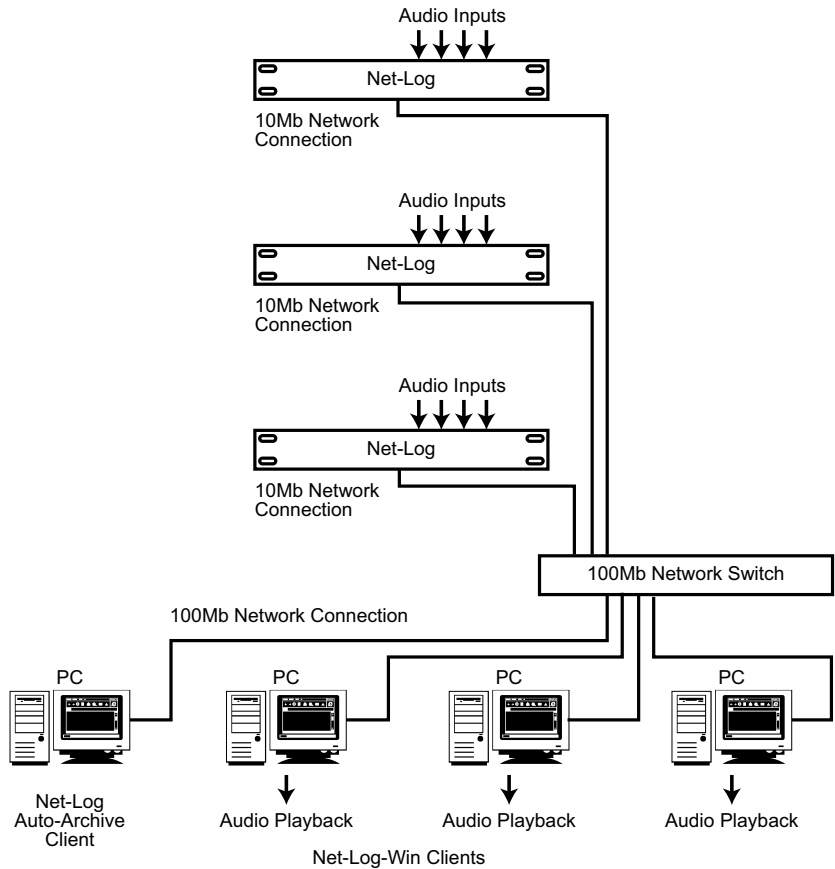

Fig 1-3: Multiple Net-Log Connection example

Network

The speed of the network connection on Net-Log is 10Mbps, and the physical connection is made via a BNC connector for coax cables, or a RJ45 connector for twisted pair cabled networks. For maximum network performance, the Net-Logs and client PCs' should be linked via a network Switch. This will cater for the Net-Logs' 10Mb connection whilst allowing the client PCs' to run at 100MB/1GB. In most applications, this arrangement will provide sufficient network performance for multiple clients to simultaneously access multiple Net-Logs. However, on existing networks where network traffic is already high, or where archiving audio from multiple Net-Logs running at high data rates, the required bandwidth of the network hardware needs to be carefully considered. In such cases a dedicated network may be required. The specification of the PC used as the Auto-Archive client will also need to be able to handle the large amounts of audio data being transferred. If the network hardware is incapable of handling the required data rates, Play Stream will be interrupted by periods of silence and audio data on the Net-Log may be overwritten before it can be archived to the target PC.

The following example illustrates a known working configuration and provides a starting point when considering larger systems.

5 Net-Logs each configured as follows:

4 mono channels of MPEG compression recording non-stop, 32 kHz sample rate, 192 kbps bit rate, archiving to a single Auto-Archive client PC via a dedicated

10/100Mb Network switch. The Auto-Archive client PC is an Intel PIII, 1GHz or equivalent fitted with a 100Mb network card.

This system provides sufficient bandwidth for continuous archiving plus the capability for additional Net-Log-Win clients to Play Stream audio.

Required Hardware

Audio can be delivered to a network-connected remote PC for live playback through an appropriate audio card. For recordings made using the MPEG format, a software codec supplied as part of the Windows XP, 7, 8 or 10 operating system, provides the decoding and conversion of the audio to a format supported by any standard Windows audio card capable of playing .wav files. Likewise, recordings made using G.729A are converted to the same Windows supported format by a software codec embedded in the Net-Log-Win software. Therefore, Net-Log-Win client PC's can play audio in both formats using a single audio card.

It is recommended to use a PC with the following minimum specification:

Pentium 166MHz

64MB RAM

Audio card & speakers as above

100Mbps network connection

Windows 7, 8 or 10

DirectX 6 or greater

2. Net-Log Hardware

Physical Description

The logger is housed in a 1U high 19" rack mount box. The front panel is chrome plated and there are chrome plated panel inserts for the fan inlet/outlet with domed labels for the "Sonifex" and "Net-Log".

Power

The unit is powered via an IEC filtered input for 95 – 265V supply at 47–63Hz, peak 60W, 30W average. There is an external fuse for the mains input that is rated at 2A. We recommend that the Net-Log is operated from an uninterruptible power supply. It should be noted that the record header is written regularly during the record process so if the power fails the data lost will be limited. At a bit rate of 192kbps this loss will be a maximum of 1 minute. Lower data rates will give proportionately greater time loss.

Level Indicators

There are four tri-colour LED's positioned on the front panel indicating input levels for each individual channel:

Led State	Meaning
Off	Input level < -18dBu
Yellow	-18dBu < Input level < 0dBu
Green	0dBu < Input level < 12dBu
Red	Input level >12dBu

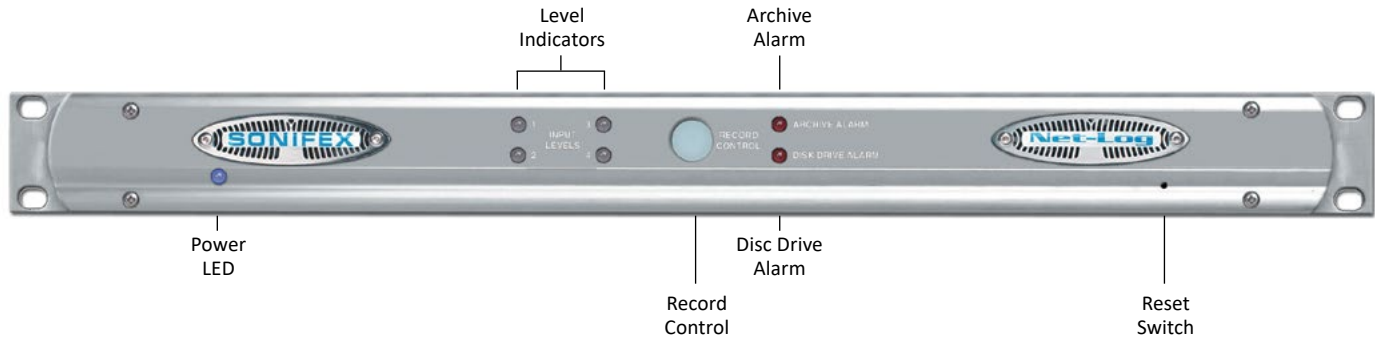

Fig 2-1: The Front Panel

Record Control/Indicator

This backlit button gives an indication of what channels are currently being recorded and can also be used to give limited control over the recording. When pressed, the button will flash indicating that a record start or stop has been initiated and must be pressed again within three seconds to confirm the action. The LED states and their relative modes are shown below:-

Button State	Mode
Off	No channels recording
Fast flashing	Record Start/Stop initiated
Slow flashing	Some channels recording
On	All available channels recording

When the button is pressed, the Net-Log checks to see which channels can be altered using this button (See Options, Record Format options, Override Enabled). If recording, a confirmed button press will stop the recording. If not recording, a confirmed button press will start the recording on enabled channels.

Archive Alarm

This red coloured LED is used to warn of loss of data during a recording process. If the Net-Log is about to overwrite data that has not been archived on to a remote computer then this indicator will start to flash. The amount of warning time you get before data is lost can be configured in the main software.

Led State	Meaning
Off	Normal
Flashing	Data is about to be lost
On	Data has been lost

Disk Drive Alarm

A red coloured LED giving an indication that there has been an error reading/writing from/to the internal hard disk.

Reset Switch

Restarts the machine. NOTE that this does not overwrite any configurations and simply reboots the machine.

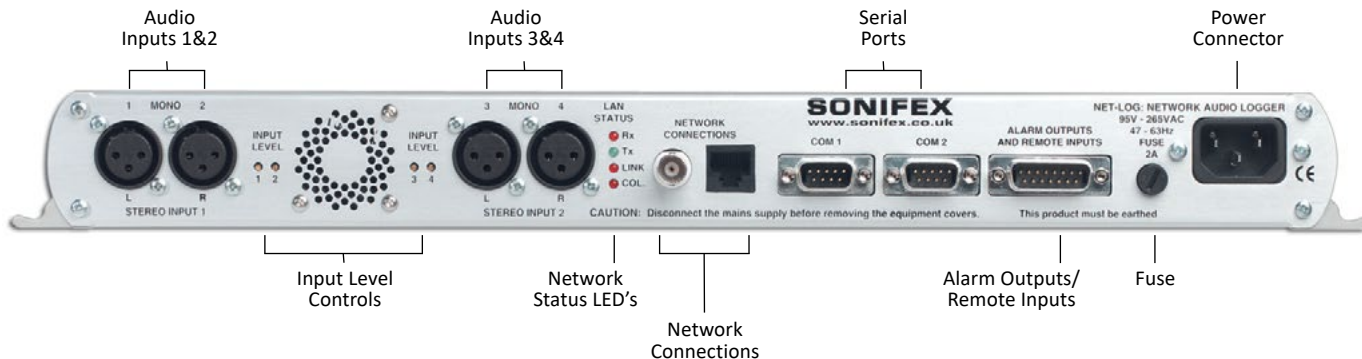

Fig 2-2: The Rear Panel

Audio Inputs/Input Level Control

The audio inputs consist of four 3-pin XLR connectors (2-channel stereo, 4-channel mono) with independent level gain controls for each input, accessible through the rear-panel using a flat-blade screwdriver.

Network Status Indicators

There are four network status indicators, which are all labelled independently.

Rx	Receiving data
Tx	Transmitting data
Link	A network link has been established
Col	Network collision

Network Connections

There are two network connectors: one a BNC (coax, 10base2), and the other an RJ45 (10baseT). Either of these can be used for TCP/IP connection.

RS232 Serial Ports

There are two 9 pin D-Type connectors (COM1 and COM2) situated on the rear panel. COM1 is used for firmware updates and for updating the network settings, i.e. IP Address, Subnet Mask, etc. It can also be used as a messaging output for data analysis. COM2 is used for the Serial Control Interface.

The settings for COM1 are fixed at:-

Baud rate	115200
Data Bits	8
Parity	NONE
Stop Bits	1

Alarm Outputs And Remote Inputs And Outputs

The remote connector is a 15 pin male D-type, which has four remote inputs to control recording, four record tally outputs to indicate which channels are recording and a double-pole-double-throw alarm output relay which activates on either the Archive Alarm or the Hard-Disk Alarm.

The remote inputs and output can be driven by 5V logic. The inputs are active low. These can be set to momentary or latching action via the Remote Options screen. The record tally outputs are open-collector driven. See Chapter 14 for pin connection details.

3. Set-up & Installation

Adjusting Record Input Levels

The peak audio input levels are preset at +12dBu. This means that an audio signal of +12dBu, once encoded, will be at the maximum digital value. To change the peak audio input level, follow the procedure below.

1. Switch the unit on and while the alarm LED's on the front panel are flashing, press the record control button. The record button will illuminate.
2. Connect a constant audio signal at the required peak level to Input 1.
3. Adjust the Input 1 level control on the rear panel until the input level LED 1 on the front panel is green.

4. Repeat steps 2 & 3 for all 4 inputs. When you have finished, simply press the record control button and the Net-Log will complete its initialisation procedure.

The peak audio input levels can be changed at any time, but it should be noted that any ongoing recordings would be interrupted as the unit has to be power reset.

Network Topology

The network that the Net-Log is connected to must be a dedicated network, if you are to guarantee the audio being available for play streaming. The ideal configuration is shown in Fig 3-1, with the Net-Log(s) connected directly to a network switch, which is connected directly to dedicated network interface cards in the PC's. It is under these conditions that the test results have been achieved in Fig 3-2.

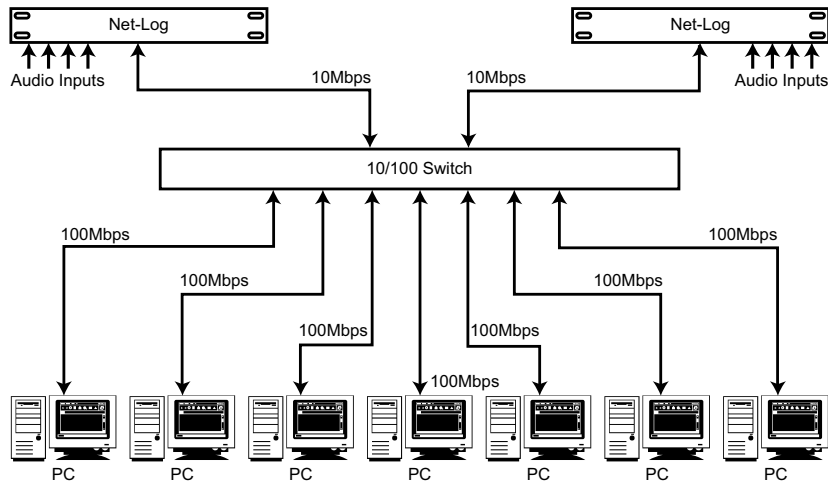

Fig 3-1: Network Topology

Maximum Network Connections

The maximum number of people that can connect to the Net-Log and use Play Streaming simultaneously is dependent on the number of software licenses that have been bought and also the data rate of the recordings that you are making. The software license is available as either a 2-stream license, or a 5-stream license. Due to the low fixed bit rate of the G.729A record format, the type of license (2 or 5 streams) is the only limiting factor for the number of simultaneous Play Streams when G.729A is selected.

MPEG Record Bit Rate	Maximum number of simultaneous streams	Total stream rate
160 kbps	5 streams	800 kbps
192 kbps	4 streams	768 kbps
224 kbps	4 streams	896 kbps
256 kbps	3 streams	768 kbps
320 kbps	2 streams	640 kbps
384 kbps	2 streams	768 kbps

Fig 3-2: Maximum Simultaneous Streams.

Fig 3-2 shows the maximum number of streams, for the MPEG record format, for the given recording bit rate configured. These figures assume that there is no other activity on the network, including Archiving of Net-Log audio. The figures show that for 5 people to be able to simultaneously Play Stream one stereo channel of MPEG audio, the recording bit-rate must be set to 160kbps or less.

If you have two pairs of stereo channels on a Net-Log set at different bit-rates, the total number of people that can Play stream them is governed by the combined bit rates of the play streaming. The limit of the maximum total stream rate is around 900kbps.

Above this stream rate, play streaming will start to fail, i.e. there will be non-continuous audio and audio silences on playback.

E.g. 2 people play streaming 64kbps recording

$$= 2 \times 64\text{kbps} = 128\text{kbps}, \text{ plus}$$

2 people play streaming 384kbps recording

$$= 2 \times 384\text{kbps} = 768\text{kbps}$$

Total = 896kbps, which is less than 900kbps and allowable.

Play streaming can occur with archiving also happening in the background. Archiving audio to a nominated hard-drive on the network happens at a maximum data rate of 1000kbps. This data rate falls if play streaming is occurring, because play streaming is given a priority over any other process. There is a downside of this priority, which is that if many people are play streaming continuously for a number of hours (or days), the archiving data rate may fall below the recording data rate, so that the audio is not being archived as quickly as it is recorded.

You can calculate whether this will happen by subtracting the total maximum stream rate (calculated in the above example) from 1000kbps. If the remainder is less than the recording bit rate that you are archiving, then your archiving may happen at less than real time and will, eventually fail. Note: this does assume that the play streaming is at, or beyond, the maximum for a considerable length of time (to fill the Net-Log hard disk). Invariably, the play streaming is for “dip-in” access of a short duration (<1 hour) and the archive process has time to catch-up when there is no, or little, play streaming.

Connecting Net-Log To Your Network

Before connecting the Net-Log you first need to give it an IP Address, Subnet Mask and a Default Gateway. You may need to obtain these from your network administrator, but please note that the Net-Log is not compatible with DHCP (Dynamic Host Configuration Protocol) and DNS (Domain Name System).

To help in your selection of an IP Address for the Net-Log, following is a brief description of how IP Addresses and Subnet Masks work.

IP Addresses

An IP Address is used to determine where a node (PC, Printer etc.) is situated on a network. This address must be unique to the network, otherwise conflicts will occur. The actual address is made up of 32 bits, split into four sections (each section is called an octet). Held in the address is a network ID and host ID.

The network ID, or network address, is basically the address of the local network, and all nodes within that network must have the same network ID. The host ID part of the address identifies the node within that network.

There are three different classes of IP Address: A, B and C. These determine what parts of the address contain the network ID and the host ID, (Fig 3-3).

IP Addresses

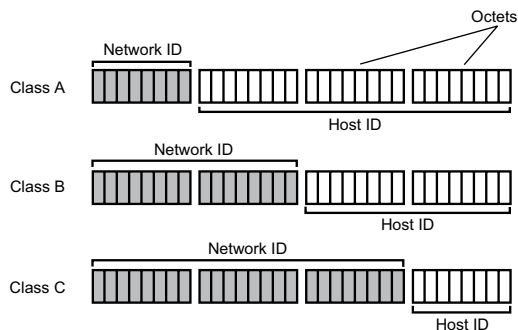

Class A example: 126.100.1.1

Class B example: 190.100.1.1

Class C example: 222.100.1.1

Fig 3-3: IP Addresses

Class A address: The first octet contains the network ID and the second, third and fourth contain the host ID.

Class B address: The first and second octets contain the network ID and the third and fourth contain the host ID.

Class C address: The first, second and third octets contain the network ID and the fourth contains the host ID.

So, the network ID of the IP Address that you give the Net-Log must match the network address of the network on which you connect it and the host ID of the Net-Log's IP Address must be different to that of any other device on the network.

Subnet Masks

To determine which parts of an address contain the network ID and host ID we use a Subnet Mask, which has an identical format to the IP Address being made up of 32-bits, split up into four octets. It is configured as follows:

For every bit in the IP Address that contains the network ID the corresponding bit in the Subnet Mask must be set to binary 1, (i.e. the byte of 8 bits is set to “255”). For example if the IP Address is a class A address, the network ID is contained in the first octet. So the first eight bits of the address contain the Network ID. Therefore the first eight bits in the Subnet Mask must be set to binary 1, making it “255.0.0.0”.

Installing Net-Log-Win Software

The procedure below describes how to install the PC software. As the initial set-up procedure will require the use of the Net-Log Serial Utility, the software must initially be installed on a PC with a free serial port.

1. Insert the Sonifex Software Installation CD into your CD-ROM drive.
2. The installation process should begin automatically. If it fails to start, select “Run...” from the Start Menu and type “x:\Index.htm” where x is the letter of your CD-ROM drive.
3. The installation starts by displaying a web page that has links to several software packages from Sonifex. Locate Net-Log-Win from the list and click on the link provided. The Net-Log-Win installation will begin as shown in Fig 3-4. Simply follow the on screen instructions to proceed. During the installation, Set-up will attempt to detect what version, if any, of DirectX is installed.

DirectX is required for audio playback and Net-Log-Win requires that version 6 or later is installed. If a compatible version is not found, then the supplied DirectX 8.0 will be automatically installed.

4. The installation will place three shortcuts in the start menu – Net-Log-Win, Net-Util and Net-Log Auto-Archive.

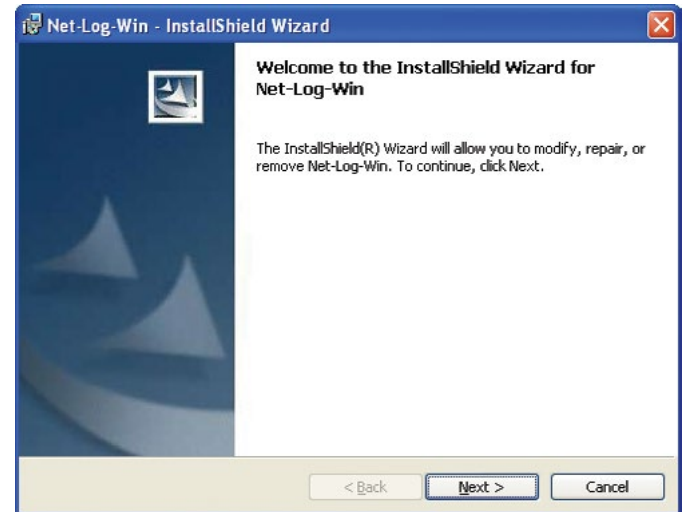

Fig 3-4 : Net-Log-Win Installation

Entering Network Settings

To do this you need to start the Net-Log-Win Serial Utility (Fig 3-5 & 3-6), and connect one of your PC’s available serial ports to the Net-Log’s serial port (COM1). This is done with the null modem cable supplied with the Net-Log.

3 Set-up & Installation

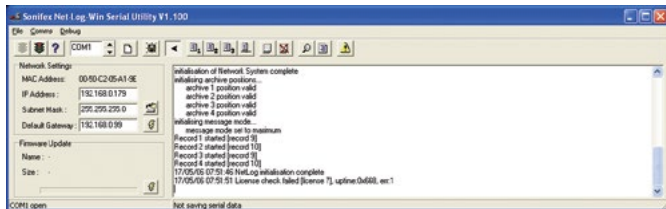

Fig 3-5: Net-Log-Win Serial Utility

Select the relevant PC COM port number in the serial utility by using the up/down buttons (labelled “1” in Fig 3-6). Now press the Connect button (labelled “2”). To test the connection between the PC and Net-Log press the question mark Test button (labelled “3”). This sends a command to the Net-Log, and waits for a reply. If there is no reply, an error message box appears declaring that the connection test has failed.

If this occurs make sure that you have the Net-Log switched on, that all cables are correctly wired and connected, and that you have selected the correct COM port number.

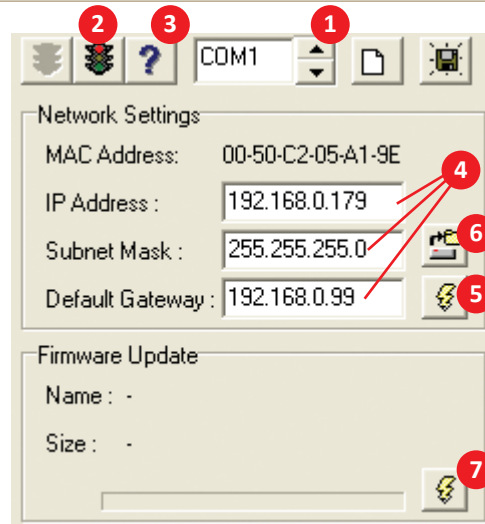

Fig 3-6: Detail of Net-Log-Win Serial Utility

The wiring for the cable is shown in Fig 3-7. If the connection is successful a message box is displayed indicating this.

Now you need to enter the IP Address, Subnet Mask and Default Gateway (labelled “4”).

The Default Gateway is defined as the target system’s default route and is a convention used on all networks. If you have a bridge to another network, then set the IP Address of the Default Gateway to the IP Address of the bridge. If you are using the Net-Log on an isolated network or directly to a single PC, then set the Default Gateway IP Address to that of the Net-Log.

Null Modem Cable

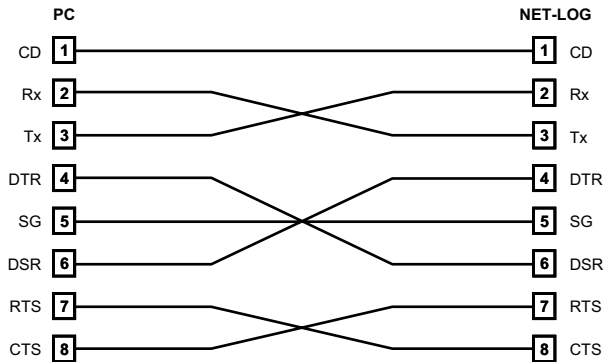

Fig 3-7: Diagram of a Null Modem Cable

Check that the values have been entered correctly and press the Download button (labelled "5"). This writes the information to the Net-Log, and stores it in the system ROM.

If at anytime you need to check the IP Address of the Net-Log you can simply press the Reload button (labelled "6"). This loads the current network settings from the Net-Log and displays them. You can edit these if you need to and write any changes to the Net-Log by pressing the Download button again.

Enter the downloaded values here for future reference:

Net-Log Serial Number:	
IP Address:	. . .
Subnet Mask:	. . .
Default Gateway:	. . .

Note: This utility can also be used to download firmware upgrades directly to the Net-Log via the serial port (instead of using the Net-Log-Win software across the network). To do this, click on the Firmware Update button (labelled "7"), select the relevant update file and press OK. The file will be downloaded to the Net-Log.

Straight Through

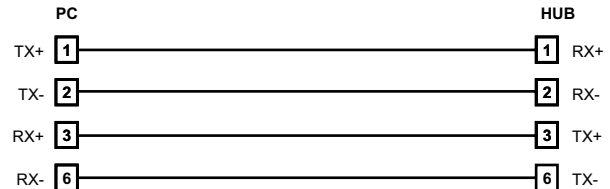

Crossover

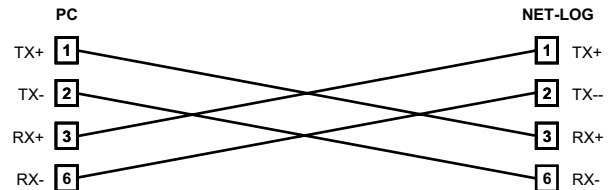

Fig 3-8: Diagram of 'straight through' and 'crossover' CATS cables

During all these procedures the messages sent from the Net-Log can be monitored in the Message window. This shows the status of the update with regards to the network settings or firmware updating.

Net-Util also provides various tools for monitoring the status and operation of the connected Net-Log. These functions are available from the menu or by pressing the button showing the right arrow symbol. When this button is pressed, the icon changes to a left facing arrow to indicate that a further press will hide the additional controls. These buttons are shown in Fig 3-9. Whilst running Net-Util, you can place the mouse cursor above the button to show a brief description of the buttons' functionality.

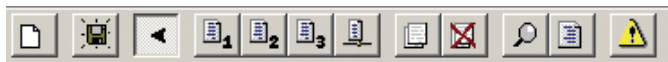

Fig 3-9: Details of Net-Util Tool buttons

The first button on the left in Fig 3-9 simply clears the main messaging window.

The next button allows the serial messages that are sent from Net-Log and displayed on the screen, to also be copied to a text file. This is particularly useful if a problem occurs on the Net-Log as the message window can only display the most recent messages.

The fourth, fifth and sixth buttons select the desired serial message mode. The button marked with a "1" selects minimum mode. In this mode, only details of fatal errors are displayed. The button marked with a "2" selects medium messaging mode. In this mode both fatal and non-fatal error details are displayed.



In maximum mode, selected by pressing the button marked with a "3", system event details are also displayed.

The next button enables network communication monitoring. This feature will display all input and output communications on the connected Net-Log and is intended for debugging purposes only – enabling it will severely affect the network performance of the Net-Log.



The next two buttons are used to display and clear the on-board message log on Net-Log. Each time Net-Log sends a serial message, it adds it to its own internal text log. This log is limited in size and only contains the most recent error/event messages.



The next two buttons are also intended as debug tools although their use will not affect Net-Log's performance. The first is used to display the current status of the network interface on Net-Log. The second is used to display record cut information.



The last button is a "Reset all" button. This will return the connected Net-Log to its factory defaults. (Please note - use of this button will delete all audio on the connected Net-Log.)



Once all the required information has been entered into the Net-Log you are ready to connect the unit to your network.

Ideally, the unit should be connected directly to a switch, but if this is not possible or practical, connecting it to a hub should be sufficient. If you are using the RJ45 connector on the rear of the Net-Log,

you should use twisted pair network cable (i.e. CAT5), wired “straight through” as shown in Fig 3-8.

If you are connecting your Net-Log directly to a network interface card in your PC, then you will require a “crossover” cable, which is also shown in Fig 3-8.

When you have the Net-Log switched on and connected to your PC or network, you can now run the Net-Log-Win software. Read the next section on Start-up and Login, which gives an explanation of the logging procedure and how to enter your Net-Log into the device list.

Note: It is important to fully configure each Net-Log prior to use. Once a successful connection has been established, refer to section 10 which details all the configuration settings.

4. Startup & Login

Starting Net-Log-Win

To start the Net-Log-Win software, select the icon from your desktop or Start menu depending on how you installed the software. The startup screen will be displayed (Fig 4-1) normally followed by the Login Screen (Fig 4-3). However the first time the Net-Log is used the license manager screen (Fig 4-2) will be displayed.



Fig 4-1: The Initialisation Screen

Maximum Concurrent Users

The Net-Log-Win software can be purchased as either a 2-stream license, or as a 5-stream license. This means that you can install the Net-Log-Win software on as many PC's in your network as you like, but that only 2, or 5 simultaneous accesses to the licensed Net-Log can be made respectively. If 2, or 5, users are using a Net-Log and another user tries to access it, a message will be displayed telling them that the allotted number of licenses are already in use.

Remember that if Archiving is enabled, this will use a license.

Multiple Net-Logs On A Network

Only one license is required per network regardless of the number of Net-Logs attached to that network. The first Net-Log connected will need to have a valid license and then all further Net-Logs should be set as slave units and will validate their license from this master. This means that the master will need to be attached at all times. If the master should be removed from the network the slave units will continue to be available for a period of 3 days. After this time they will still continue to record but will be inaccessible from the Net-Log-Win software. Reconnecting the master unit will re-enable all features.

Licensing Your Net-Log

The License Manager Screen (Fig 4-2) is shown when first connecting to a Net-Log or can be accessed from the Administrator menu. This dialogue shows the unique boot code used to validate the master licenses and the 3 licensing options. These allow the user to set the unit as a master by entering the license code; as a slave by entering the TCP/IP address of a connected Net-Log master unit; or define the unit as a demo. Similar to disconnected slave units the demo allows for 3 days of normal operation and the unit can be upgraded at any time to function as a master or as a slave by entering the appropriate data. (Please note - Re-selecting the unit as a demo will delete all audio data and settings from the Net-Log.)

Obtaining License Codes

The license code must be obtained directly from Sonifex. You can do this in several ways, either by phone to Sonifex on +44 (0)1933 650700 during normal UK working hours; or by sending the form from the front of the manual by fax to +44 (0)1933 650726 or directly by post; or by completing the form on the supplied link or through our website www.sonifex.co.uk/netlog; or by supplying the information indicated on the form by email to netlog.support@sonifex.co.uk. Sonifex will endeavour to return the license codes as quickly as possible. In the mean time the machine can be used as a 2-stream license demo machine for 3 days.

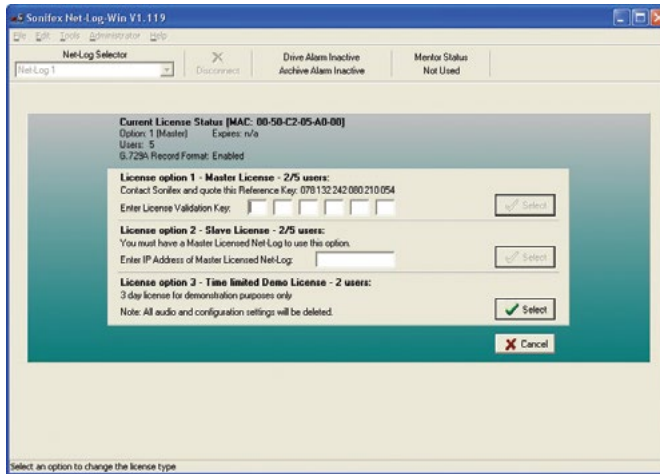

Fig 4-2: The Licensing Screen

The Login Procedure

To enter the system, all users must specify a User Name and a Password.

These will then be compared to details which are stored onboard the Net-Log before the user can access the system. If the user enters the correct information, they will be allowed to use the PC interface to control the designated logger. If the user enters incorrect information, they will be asked to re-enter the User Name and Password.

To configure the system, enter a User Name of “admin” and a Password of “admin”. The password should be changed once you are running the program.

There is a Net-Log Device List, which allows you to choose one of any number of Net-Logs connected to the network. When the software is loaded for the first time, no Net-Logs are available in the Device List, and

a message box appears stating this. You will be taken automatically to the Device List editor, where you can add your Net-Log into the list.



Fig 4-3: The Login Screen

The Device List Editor

To enter a Net-Log into the list you must give it a text name and the IP Address that was downloaded into the Net-Log as described in the “Setup & Installation” chapter. Once you have entered the Name and IP Address into the boxes, press the “Add” button, and it will now appear in the list.

The two up/down arrows on the right hand side are used to select the default Net-Log used when you have multiple units. The default unit is the one that is automatically selected when you login.

Multiple Net-Logs can be Added, Deleted and Replaced. See Fig 4-4.

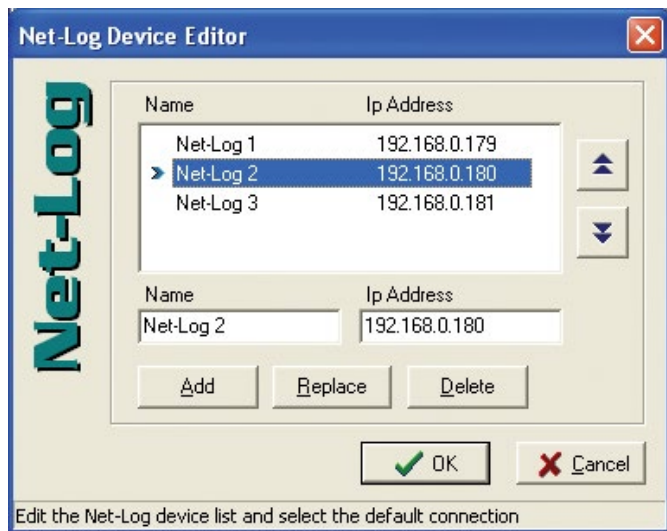

Fig 4-4: The Net-Log Device List Editor

To edit the name or the IP Address of a device, select the unit in the list and edit its details that appear in the Name and IP Address text boxes. When you have finished, click the “Replace” button.

To delete a device contained in the list, select the unit, and then press “Delete”. Once you have finished entering the details of your Net-Log(s) into the device list press “OK”. This will return you to the Login screen.

Note: Prior to logging on to a new Net-Log for the first time, ensure that the clock on the PC is set correctly as this time will be used to update Net-Log’s onboard clock.

The software will attempt to connect to the Net-Log and when a connection has been established you will see the main screen.

If the main screen does not appear then there is a problem connecting to the Net-Log. Check that the IP Address entered in the device editor list is the same as the one downloaded using the Net-Log-Win Serial Utility. Secondly, check that the IP Address and Subnet Mask are valid for your network. If invalid details are entered, the Net-Log will not appear on your network (see your system administrator for more information).

First Time Use of Net-Log

The first time you use the Net-Log you will need to setup the configuration for your particular application. The configuration is accessible from the Options tab. See Chapter 9 for full details. At the very minimum you will need to set up the Record Format, Record Media and Clock Source options.

Changing User Details

Once you have logged in for the first time it is advised that you change your User name and Password from the default settings to stop unauthorised access to your user account. To do this, select the Edit menu, and then User Details (Fig 4-5). Enter your new details and press “OK”. If the “Cancel” button is pressed, none of the changes made will take effect.

Note that the password is case sensitive, and you must re-enter the password to confirm it is correct.

There is a special case available to demonstrate just the screen layout and use of the Net-Log-Win software that can be initiated by selecting a user name of demo and leaving the passwords blank.



Fig 4-5: User Details

General Screen Layout

After logging in, the main screen appears (Fig 4-6). Whether all of the 4 main selection screens (Record, Archive, Play and Options) are displayed will vary depending on the user account that you have logged in with. However, the screen layout will remain the same throughout.

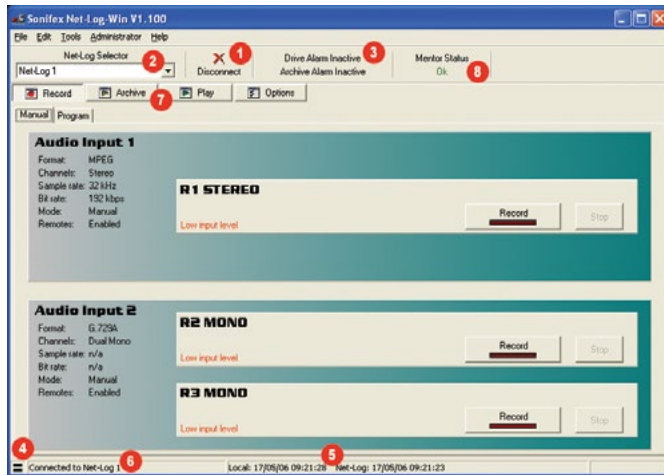

Fig 4-6 General Screen Layout

1 Disconnect/Log-Off Button

If you are currently connected to a Net-Log then this button allows you to disconnect and select a different unit. If you are not currently connected to a Net-Log, this allows you to log off and either log on as another user, or exit the application. Note that logging off, or disconnecting, from the Net-Log will not affect the operation of the Net-Log, i.e. it won't stop it recording, etc.

2 Net-Log Selector

Use this to select other Net-Logs from the drop-down list and connect to them as the user that you are currently logged on as.

3 Alarm Indicators

These replicate the LED alarms situated on the front panel of the Net-Log. The alarm conditions are also available on the remote connector.

4 Network Activity Indicators

These are transmit Tx (left, red) and receive Rx (right, green) indicators showing data transfer between the Net-log and your client PC.

5 Net-Log & PC Time

Date and Time of the Net-Log clock and the local PC clock

6 Status Bar

General information is displayed here.

7 Screen Selection Buttons

These are used to switch between the different screens that are used to control the Net-Log.

8 Mentor Status Indicator

Status of the Mentor Time Server, used for synchronising the PC and Net-Log times on a network.

5. Recording

The Record Screen

This is where all recording actions are controlled. Each input channel (up to a maximum of four mono, or two stereo channels) can be controlled independently and is represented by a separate display panel. Each panel shows the current configuration and state for that channel. For convenience, it also monitors the levels of the audio inputs, and gives an indication of when there is “silence”, defined as an input of below -44dB, as shown in Fig 5-1. The record channels are configured using the Options screen.

There are two formats available for recording, MPEG and G.729A. MPEG allows for mono, dual mono and stereo channel selection as well as variable sample and bit rates. G.729A is a high compression, fixed bit rate, mono or

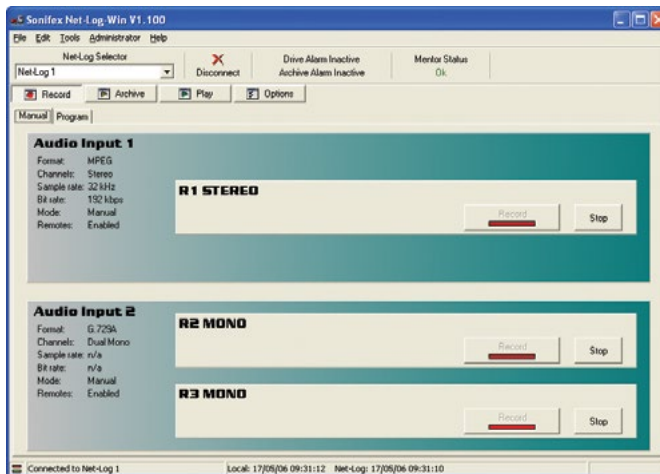

Fig 5-1: Manual Record Screen

dual mono record format. Its low bandwidth makes it ideal for recording speech and gives very high storage capability – approximately 13 minutes per Mbyte. G.729A can be used only after purchasing an additional license. Contact Sonifex Ltd for details.

The Net-Log allows five methods of recording:

Manual Recording

Button presses control recordings on each logger channel.

Program Recording

Record control occurs automatically by defining a “time-sheet” for each channel.

Auto Recording

Record control occurs automatically as the input audio level rises above and below user-defined start and stop threshold levels. Auto record mode is not available when using the G.729A record format.

Remote Recording

Recordings can be started/stopped by connecting certain pins on the rear panel remote connector.

Serial Recording

Record is controlled by commands sent to the Net-Log via the Serial Port. See chapter 8 for protocol information.

Remote or Serial recording will operate regardless of whether Manual, Program or Auto record mode is selected in the Record Options page. Care should be taken to ensure the correct mode of operation is selected as no priority is given to either Remote or Serial recording when co-configured with Manual, Program or Auto record mode.

Note: The Net-Log can record up to a maximum of 250000 tracks on each configured partition on the hard drive. When the end of a partition is reached, recording continues at the start of the partition – over-writing

existing data. Each time the record “loops” back to the beginning of a partition, the track count is reset and a further 250000 tracks are available. Once the 250000-track limit is reached, subsequent recordings will be appended to the 250000th track.

Manual Recording

To start recording manually, select the “Manual” tab, choose the channel you wish to begin recording on and press the relevant “Record Start” button. The Net-Log will start recording and the on-screen LED will illuminate red to indicate this.

Once recording has started, the Record Control button on the front panel of the Net-Log will light up accordingly, and a track list entry will also be created in the play screen. To stop the recording, press the “Stop” button. The Record Control button will change accordingly and the track list entry in the play screen will now contain an end-date and time.

Program Recording

To set-up a program recording you must first make sure that you have a channel enabled to do this. See the Record Format tab of the Options screen – Section 9. Once enabled, you can select the “Program” tab in the Record screen. The Program Record screen will be displayed (Fig 5-2).

This shows a time sheet for a complete week, with the seven days of the week along the left-hand side and the time of day along the top.

Select the record channel that you would like to program by using the left/right arrow buttons.

The time sheet works by defining a Program number and editing the start time and duration. The Program number is then assigned to any of the days by selecting the associated tick-box. Up to 20 Program numbers can be defined.

A graphical representation of the program is displayed.

Note that if you alter a start-time or duration once programmed, the graphic display will alter also to reflect the changes.

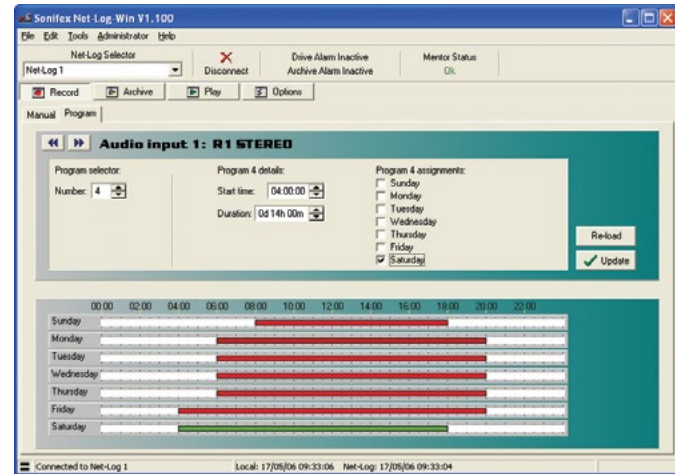

Fig 5-2: Program Record Screen

Additional options are available to assist with setting up the record programs. These options are accessed by pressing the right mouse button whilst the cursor is positioned over the record program screen. A popup menu will be displayed as shown in Fig 5-3. The first two options allow you to quickly assign the currently selected program to either run every day or not run on any day. The next three options can be used to clear programs. Clearing a program resets the start time and duration to defaults and removes all the day assignments. The last two options allow you to make copies of programs.

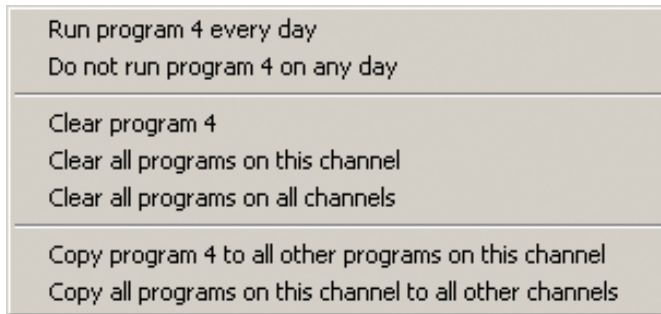

Fig 5-3: Program Record Popup Menu Commands

Click on the “Update” button to send the program to the Net-Log. The record start and stop times are stored on the Net-Log and recording will now start and stop automatically. Storing the information on the Net-Log allows the recording to be made even if there is a network problem at the time the recording state is due to change, and allows everyone to see the record programs being used.

If you need to change the program times for a particular Net-Log, or just want to view them, the display will be refreshed automatically when you select the Net-Log, or you can press the “Re-load” button, which gets the information from the connected Net-Log.

If you make alterations in this screen and wish to cancel them, then simply leave this screen, or press the “Re-load” button to show the existing settings.

Note: If the Net-Log is currently using a program recording, and you update it with a new program, the current state of the recording will reflect the new program state.

E.g. if the Net-Log is recording at 4pm on a Monday and a new program is loaded at that time which has a record stop at 3pm and record start at 5pm on a Monday, the recording will stop. It will then restart recording at 5pm.

Saving and Loading Record Programs

Once you have finished setting up the record programs, you can make a copy of them on a PC. This can be particularly useful if you have more than one Net-Log and you want each machine to follow the same programs.

To save the complete set of record programs for the connected Net-Log, select File, Save As from the main menu. A dialogue will be displayed allowing you to specify the location and name of the file that will be used to store the current program information. Once you have made these selections, press Save.

To load a previously saved file, select File, Open and then select the file that contains the required program information.

Please note, you can only load and save programs whilst in the record program screen.

Auto Recording

To use auto recording, you must first make sure that the auto record mode has been selected, and the auto start and auto stop parameters have been set as required. See the Record Format tab of the Options screen – Section 9.

To start auto recording, press the relevant “Record Start” button. The channel display will show “Waiting for auto start level...”, and the Net-Log will start recording automatically when the input audio level rises above the auto start threshold. The on-screen LED will illuminate red to indicate when a channel has started recording.

Recording will continue until the input audio level falls below the auto stop level threshold, at which point the recording is provisionally ended. The input audio level must then remain below the stop level threshold for the period of time set by the stop duration, otherwise recording will continue.

Once a recording has ended, the length of the new cut is compared to the auto start duration. If the new cut length is less than the auto start duration, it will be automatically deleted.

The process is then repeated the next time the input audio level rises above the auto start level threshold.

To stop auto recording at any time, press the “Stop” button.

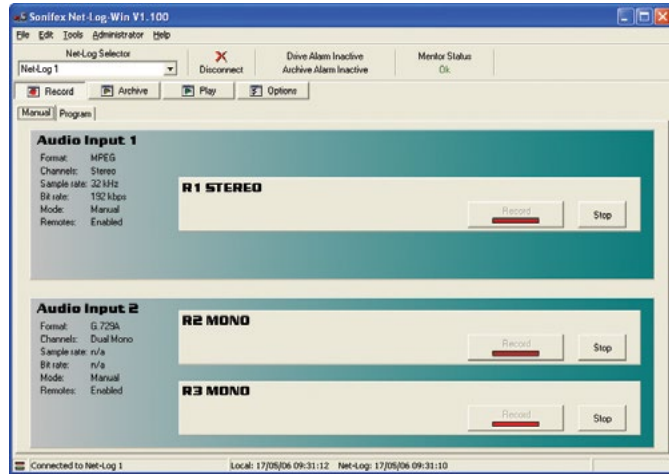

Fig 5-4: Auto Record Mode

Remote Recording

Recording for each channel can also be started remotely using the 15 Pin D-Type socket found on the rear of the unit. There are four record input pins that can be assigned as momentary or latched in the Record Remotes Option screen.

Serial Recording

Serial Recording allows external equipment connected to the Net-Log via a serial communications link, to start/stop recordings. There are currently two interfaces supported. See chapter 8 – Serial Control Interface.

Record Tally Outputs

Each record channel has a ‘Record Tally Output’ that is active when the associated channel is recording. For example, if channel 1 left is currently recording, then Record Tally Output 1 will be active. Likewise if channel 4 right is also recording, then Record Tally Output 4 will be active. These outputs are independent of the record mode selected.

The Record Tally Outputs are open-collector driven, and are available using the 15 Pin D-Type connector on the rear panel of the unit.

See section 14 Technical Specification for details of all of the remote input and output pin connections.

6. Playing & Downloading

Audio recorded on the Net-Log can be accessed in two ways. Firstly, you can download a selected piece of audio straight to your hard drive, and then play it either using the embedded player (Fig 6-5), or for MPEG, Linear or MP3 recordings, the Windows Media Player. G.729A recordings can only be played using the embedded player. Alternatively, you can stream audio directly from the Net-Log and listen to it whilst it plays.

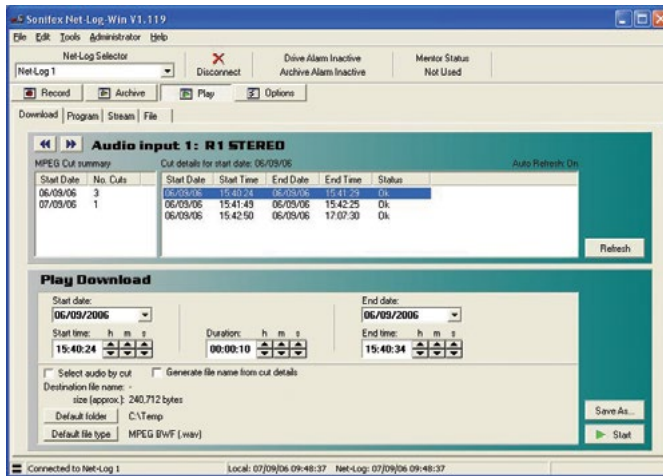

Fig 6-1: Play Download Screen

Track List Display

The track list display is shown in Play Download, Play Stream and Play File. The Net-Log can record up to 250000 tracks per channel. To make it easier and quicker to find the required audio for playback, the recorded track display is split into two parts. The list on the left shows a summary of tracks that exist on the selected channel, indicating the start dates and number of tracks that were started on that date. Click on the required date to load

the list on the right with details of each track recorded on that date. The “Refresh” button is used to refresh both lists to include any newly recorded tracks. Select the left/right arrow buttons to change the channel.

The “Cut summary” list is, by default, loaded automatically when entering the play screen, or when selecting a different channel. In addition, both lists will be updated if a new recording is initiated on Net-Log. This auto refresh feature can be disabled by selecting Tools from the main menu, and de-selecting the “Auto Refresh Cut Display” option. It is particularly useful to have this option disabled if you record a large number of tracks on a daily basis, as it prevents the lists being updated every time a new recording is made.

Play Download

Downloading can be used to get a piece of audio from the Net-Log, which can be saved as a file for playback later or for emailing/forwarding to a colleague or customer.

Select the “Download” tab to select the Play Download screen (Fig 6-1). There are two methods of selecting audio for download, by entering the start date and time and the duration of the required piece of audio, or by selecting a track and downloading it in its entirety.

To download a piece of audio by selecting the start date and time, ensure the “Select audio by cut” check box is not ticked. Then click on a track and its time and date details are automatically entered into the Download section. Alternatively, use the right mouse button to load the end time and date of the selected track. This is particularly useful for selecting audio near the end of a track.

The start time, start date and duration can be altered to get the exact piece of audio required. You can also use the end date and time controls to set the effective duration of the required audio. Highlight the hour, minute, second, day, month, or year and by using the up and down spin wheels to alter the value. Alternatively, you can enter the required value directly.

The file size is calculated as you change the duration and is displayed below the time and date selection boxes.

To download a complete track, ensure the “Select audio by cut” check box is ticked and select the track to highlight it ready for downloading. Multiple tracks can be selected by holding down the Ctrl key on the keyboard and clicking on additional tracks.

There are several file formats available for tracks recorded using the MPEG format. Press the “Default file type” button to select MPEG BWF, Raw MPEG, Linear BWF or MP3. For MP3 files, the bit rate of the target file can also be selected. Recordings made using the G.729A format cannot be converted to other formats.

Once you have made your selections for play download, press the “Start” button, and if a destination file has been selected the download will start. Otherwise you will be asked to specify a destination file and then the download will start automatically.

The file name for the download can be automatically generated by selecting the “Generate file name from cut details” check box. In this mode, the file name will be based in the start date, start time and duration of the selected piece of audio. When the “Start” button is pressed, the file is created automatically and the download will begin. To use this option, you must have a default directory selected. Press the “Default directory” button to choose the directory where the file will be placed.

For tracks recorded using the MPEG format, the file is created with either a .wav, .mp2 or .mp3 suffix depending on the file type selected. For G.729A tracks, the file extension will be .g7a (see Play File for file type description). MPEG, Linear and MP3 downloads can be played either with the embedded player (Fig 6-5), Windows Media Player or any other capable-software.

G.729A recordings however, can only be played on the embedded player, as Windows Media Player does not support this format.

Play Program

The Play Program screen allows audio downloads to be scheduled. Each program contains details of the audio to be downloaded, the format of the downloaded file and an optional date and time when the download is to take place. Each program can specify a single download, or multiple downloads for specific days between selected dates.

Select the “Program” tab to select the Play Program screen (Fig 6-2). The upper part of the screen shows the program summary. This is a list of all pending and active programs for the selected channel. It also shows completed programs that have either not been automatically deleted, or have encountered an error. Select the left/right arrow to change the channel and refresh the program list. The “Delete All” button deletes all programs for all channels.

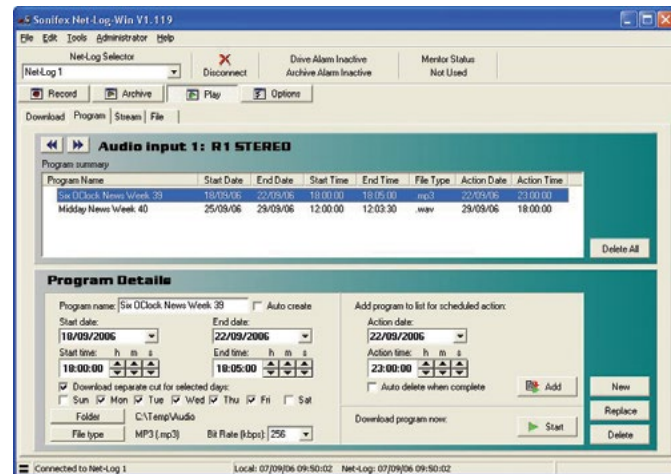

Fig 6-2: Play Program Screen

The lower part of the Play Program screen shows the details of the selected program. Click on an existing program in the list to load the details. Use the “Delete” button to delete the highlighted program, or the “Replace” button to replace the highlighted program with the program currently shown in Program Details.

To add a new program, press the “New” button. Each program requires a name which uniquely identifies the program in the list. The name can be entered manually, or it can be created automatically by ensuring the “Auto create” check box is ticked.

To configure a program to download a single track, ensure the “Download separate cut for selected days” check box is not ticked. In this mode, the start date and time and the end date and time controls directly select the piece of audio to be downloaded.

To configure a program to download multiple tracks, tick the “Download separate cut for selected days” check box. In this mode, the start and end time controls specify the piece of audio to be downloaded. The start and end date controls specify the range of dates from which the selected piece of audio will be downloaded. The check boxes, marked “Sun” though to “Sat” allow you to select the specific days, between the start and end date, that each track will be downloaded.

For example, you want to download an audio clip that starts at 9:00am and continues to 9:30am on Monday 4th September 2006. You also want to download the same clip from the following Wednesday and Friday mornings. First you would set the start date to 04/09/2006 and the end date to 08/09/2006. Then you would set the start to 09:00:00 and the end time to 09:30:00. With the “Download separate cut for selected days” check box ticked, ensure only the required day check boxes, “Mon”, “Wed” and “Fri” are ticked.

The directory where the downloaded audio will be placed is selected by pressing the “Folder” button. When a program download starts, a sub-

directory of the selected folder is created using the program name, and the file is saved to this sub-directory.

For tracks recorded using the MPEG format, the file type of the downloaded audio can be MPEG BWF, Raw MPEG, Linear BWF or MP3. Pressing the “File type” button repeatedly, cycles through the available types. For MP3 files, the bit rate of the created file can also be selected. For tracks recorded using the G.729A format, the file type is fixed.

Once your program selections have been made, you can select whether the program download is to be scheduled for completion at a later time, or started immediately. To schedule the program to run at a later time, select the required date and time using the action date and time controls. You can also select whether the program is automatically deleted once it has completed by ticking the “Auto delete when complete” check box. If you select this option, the program will not be deleted from the list if an error occurs during the download. Press the “Add” button to add the program to the list. To execute the program immediately, press the “Start” button. In this mode, the program will be added to the list temporarily while download is completed. Once complete, the program will be removed from the list provided no errors occurred during download.

A small green tick will appear next to the program name for programs that have successfully completed. A yellow triangle with an exclamation mark indicates programs that have encountered an error. An hour glass next to a program in the list indicates that the program is currently active. By default, the progress of play programs is logged to a file on the PC. See section 11 Tools for details of the play program log.

Play Stream

Select the “Stream” tab to select the Play Stream screen (Fig 6-3). Select the left/right arrow to change the channel. Only one mono or stereo channel can be played at any one time. Select the track that contains the piece of audio that you want to stream.

The start time will be entered in the Stream section of the display. Alter the time and date of the track to the time and date of the recording that you wish to hear.

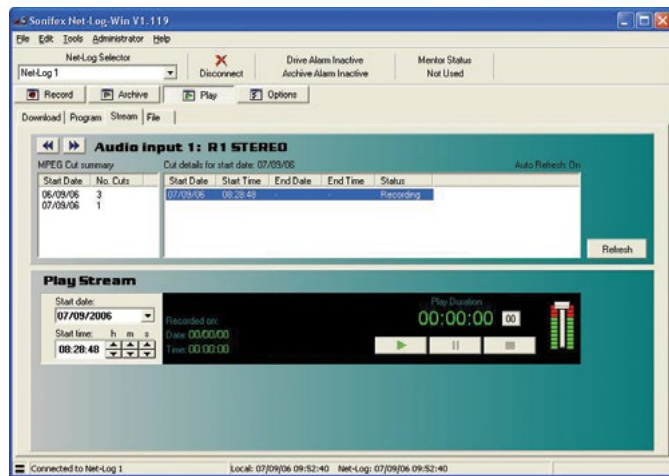

Fig 6-3: Play Stream Screen

Press the “Play” button to hear the audio. It will take a few seconds to access the audio from the Net-Log and to stream it across your network. The Recorded Time and Recorded Date are displayed during playback. You can use the “Pause” and “Stop” buttons to pause and stop the audio respectively. Pressing the “Stop” button will recue the audio back to the “Play from ...” time and date. The slider on the right can be used to alter the volume of playback and the “00” button is used to reset the “Play Duration” counter.

There is a minimum delay for playing audio from a currently recording track. If the selected play time is within this minimum time, a message box will be displayed allowing play to automatically start playing once sufficient audio data exists. See Fig 6-4 for details of the minimum play stream delays.

Sample Rate	Minimum Delay Times for Play Stream on Currently Recording Track
16 kHz	115 seconds
22.05 kHz	85 seconds
24 kHz	79 seconds
32 kHz	60 seconds
44.1 kHz	45 seconds
48 kHz	42 seconds

Fig 6-4: Minimum Play Stream Delays

Play File

Select the “File” tab. The Play File screen shown in Fig 6-5 is for playing archived or downloaded files. The screen layout is similar to the Play live screen.

The Play File screen is split into two parts; play control and the play list. Audio files are loaded into the play list by pressing the “Open...” button, and selecting the required file(s). Audio files of all supported formats can be loaded into the play list. Single entries in the play list can be deleted by highlighting the entry and pressing the “Delete” button. Alternatively, the whole play list can be cleared by pressing the “Clear” button.

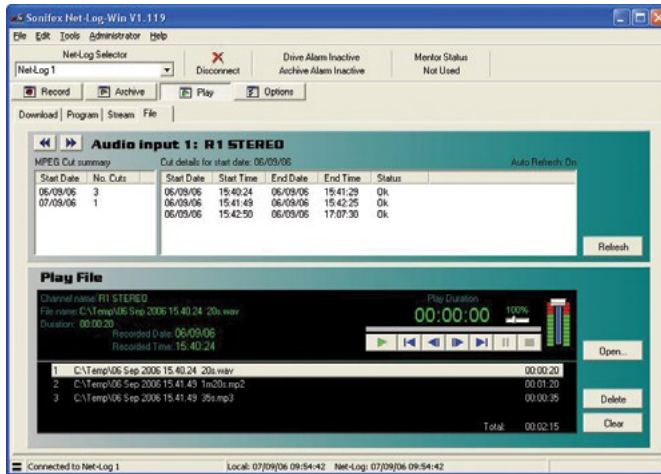

Fig 6-5: Play File Screen

To play the current play list, press the green “Play” button. Play starts at the entry highlighted in the play list and continues to the end of the list. There are other controls including next/previous track select, seek, pause and stop with an extra control for altering the playback speed of the file. This is situated alongside the volume control. The volume control is equivalent to the Wave Output volume control on the Windows Mixer, usually situated in the Windows System Tray.

When an MPEG file is archived or downloaded from the Net-Log, the file can be created as either a raw mpeg data file (.mp2), or as a broadcast wave format file (.wav). Creating a broadcast wave format (bwf) file allows additional information about the recording to be stored and recalled on playback. Creating an mp2 file doesn’t allow this information to be recorded. G.729A files are created with this additional information automatically included.

The MPEG bwf and G.729A recordings contain information specific to the file, including the recording format of the file, the origination time of the file, the MAC Address of the Net-Log that it was recorded on and the name of the recording, etc. The origination time and date of the file, together with the file name and file duration, are displayed when the corresponding entry in the play list is selected or played.

7. Archiving

The Archiving Process

Archiving is the process of getting Net-Log to automatically and continuously create audio files (.wav, .mp2 or .g7a files) on a selected drive or device. Long recordings can be re-formatted into smaller files of a fixed duration for ease of use.

Typically, this is so that a long-term archive of recorded material can be stored on a separate hard-drive, such as on a server, where many people can access historic files without interfering with the operation of the Net-Log. Additionally, the server could then be used to make permanent archives on to CD-R, DAT, or DVD-R, using conventional low-cost IT technology.

Configuring Archival To A Networked PC

Enter the Options screen and select the “Archive” tab (Fig 7-1). To configure the options correctly you need to know the IP Address of the networked PC and the designated share name of the folder to which you want to archive to. You must also have write access to this folder.

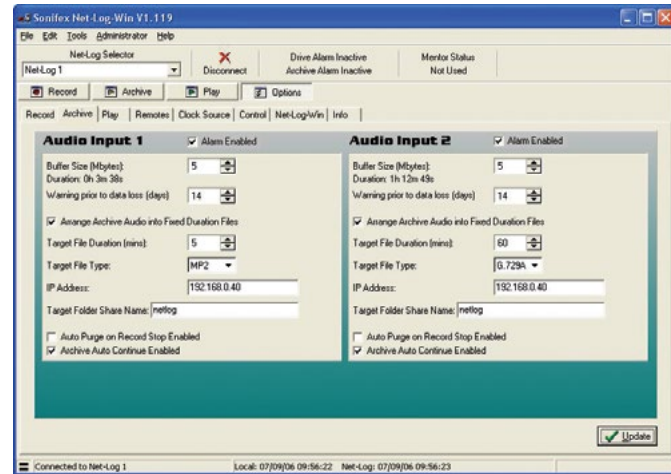

Fig 7-1: Archive Options Screen

Archiving is configured for individual recording channels, or pairs of channels, depending on the recording options settings. For each channel, the following settings should be configured:

Alarm Enabled

This option allows you to disable the archive warnings and alarms. It is primarily for users who don't wish to use Archiving and therefore don't want the distraction of having the archive warnings and alarms activating when data is overwritten.

Buffer Size

The buffer size (5-1000Mbytes for MPEG, 1–200Mbytes for G.729A) is the amount of un-archived data stored on the Net-Log before archiving will start. If you set the buffer to 150MB, the Net-Log waits until it has that much data before it archives to the selected destination. The size of the buffer you select is really dependent on network activity. If your network is quite busy you might want to set the buffer at a relatively low size (5-50MB).

Warn Time

In normal operation, the Net-Log records continually, overwriting information initially recorded on the drive when it reaches the end. The warn time is the amount of time prior to data loss on the Net-Log (5 mins to 14 days) and provides a warning that data will soon be overwritten which has not been archived. Once data is overwritten, the archive alarm will activate. Please note that if you have a busy network you should set this time quite high to give enough time to archive the data. This option has no effect if the Alarm Enabled option is disabled.

Arrange Archive Audio into Fixed Duration Files

When this box is ticked, the audio transferred from the Net-Log to the archive destination drive will be split into fixed length files, determined by the Target File Duration option. Without this option enabled, the audio files will appear on the archive destination drive as they do on the Net-Log.

Target File Duration

This is the duration (5 – 60mins) of the files that will be created on the destination drive. For example, if it is set to 5 minutes then the files on the target drive or device will be of a five-minute duration. This option is only valid when the “Arrange Archive Audio into Fixed Duration Files” box is ticked.

File Type

This determines the type of file that is created (.wav, .mp2 or .g7a).

Destination IP Address

This is the IP Address of the PC on the network that you want to archive to.

Target Folder Share Name

This should be set to the share name of the folder where you want the archives to be stored at the destination IP Address. Only the share name should be entered, not the path of the shared folder. To find the share name, locate the target folder in Windows Explorer, then right click on this folder and select “Properties”, then “Sharing” from the popup menu. When the archive begins, sub-folders will be created automatically.

Auto Purge on Record Stop Enabled

When this box is ticked, all available audio is archived each time a recording is ended.

Once you are happy with the settings, press the “Update” button, and they will be written to the Net-Log shown in the Net-Log selector.

Format of Archived Files

The archived files are stored in sub-directories beneath the directory name that you have defined. The format is (depending on the selected file type):

```
\IP Address\Service Name\dd-mm-yyyy\hh-mm-ss.wav
```

or

```
\IP Address\Service Name\dd-mm-yyyy\hh-mm-ss.mp2
```

or

```
\IP Address\Service Name\dd-mm-yyyy\hh-mm-ss.g7a
```

Where IP Address is the Net-Log’s IP Address, Service Name is that defined in the Service Name tab of the Options, dd-mm-yyyy represents the date of the recording in day-month-year format and hh-mm-ss is the start time of the recording in hours-minutes-seconds format.

Beginning to Archive

To start archiving, select the Archive screen and press the “Archive Start” button (Fig 7-2) for the particular channels that you wish to archive.

The LED in the button will illuminate when data is being archived (i.e. transferred from Net-Log to the PC).

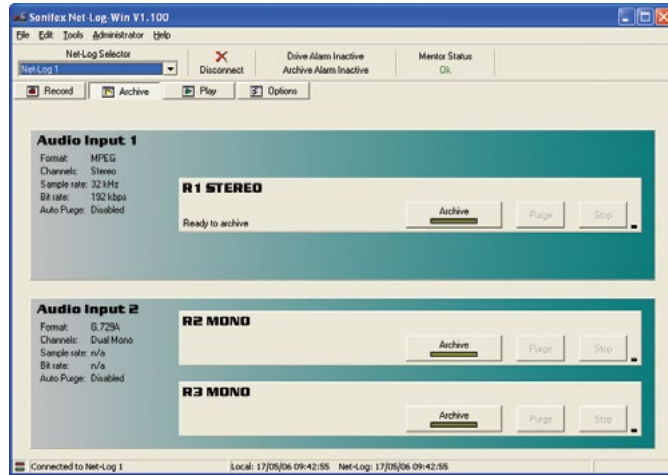

Fig 7-2: Archive Screen.

If you want to stop the archive process, simply select the “Stop” button.

Note: You can only archive audio data from the Net-Log that you are currently logged on to. If you disconnect, all archiving will stop. See section 12 – Auto archive, for details of how to archive data from one or more Net-Logs simultaneously and without having to logon/logoff.

8. Serial Control Interface

The Serial Control Interface allows external equipment to remotely control several functions of the Net-Log. Each of the available interface protocols have been designed according to customers' specific requirements.

Additional interface options may be added in the future; please contact Sonifex Ltd for further details.

To enable the Serial Control Interface, enter the Options screen and select the "Control" tab (Fig 8-1). From the drop down list, select the required Control Interface type. If the drop down list is disabled, this means the firmware in the connected Net-Log has not got the Serial Control Interface enabled, or a later version of firmware is required.

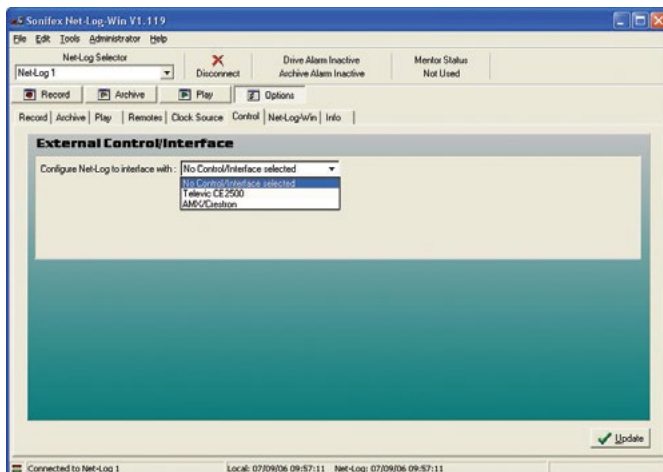

Fig 8-1: Control Options Screen

The Interface types currently available are:

- Televic CE2500
- AMX/Crestron

When a Control Interface type is selected from the list, the available settings for that type will then be displayed.

Televic CE2500 Interface

The Televic CE2500 is the central control unit of Televic's Digital Conference and Interpretation System. This interface provides automatic record start when the Conference Systems' microphones are activated. The recording is then stopped when the microphone is deactivated. The Net-Log also extracts the microphone number and the name of the speaker from the microphone activation command and stores this information on the internal hard disk along with the normal cut information. This additional data is then displayed in the Play screens cut list. The Net-Log can currently support up to 128 microphones.

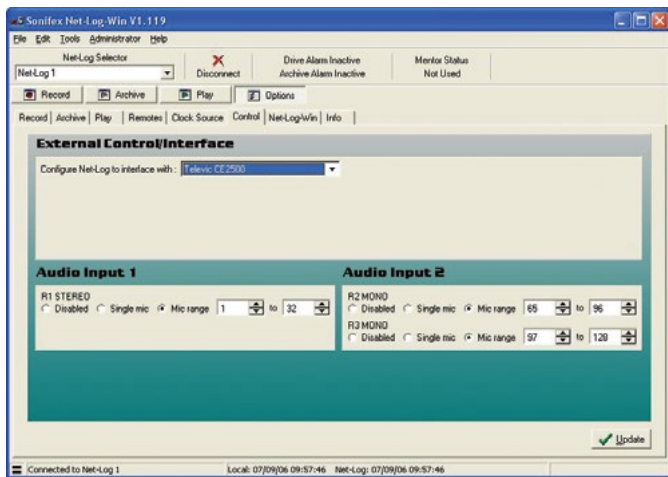

Fig 8-2: Televic CE2500 Interface Options

The settings relating to this interface allow the available record channels to be associated with specific microphone numbers. Each channel is displayed according to the Record option settings. In Fig 8-2, Audio Input 1 is configured as stereo and Audio Input 2 is configured as dual mono. Each available channel is identified by the service name also given in the Record options.

Note: Only one microphone number and name can be stored per recording, so the last one used is stored.

Each channel can be configured in one of three modes:

Disabled

When this option is selected, the channel will not be controlled by any of the microphones on the Conference System.

Single Mic

This selection configures the associated channel to be controlled by a single microphone. The microphone's identification number can be entered in the edit box. Alternatively use the up/down arrows to select the required identification number. The lowest microphone number is 1 and the highest is 128.

Mic Range

This selection configures the associated channel to be controlled by a range of microphones. Activating any one of the microphones in the specified range will start the channel recording. The channel will only then stop recording when all microphones in the range have been deactivated. Again the lowest microphone number is 1 and the highest is 128.

The settings for Single mic and Mic range can overlap such that a microphone can control multiple record channels.

Once the required settings have been entered, press the "Update" button, and they will be written to the Net-Log shown in the Net-Log selector.

The cut list display in the Play screen in Net-Log-Win will now show two additional columns: Mic and Name (see Fig 8-3). These new columns display the Mic number and the Name of the speaker who initiated the recording.

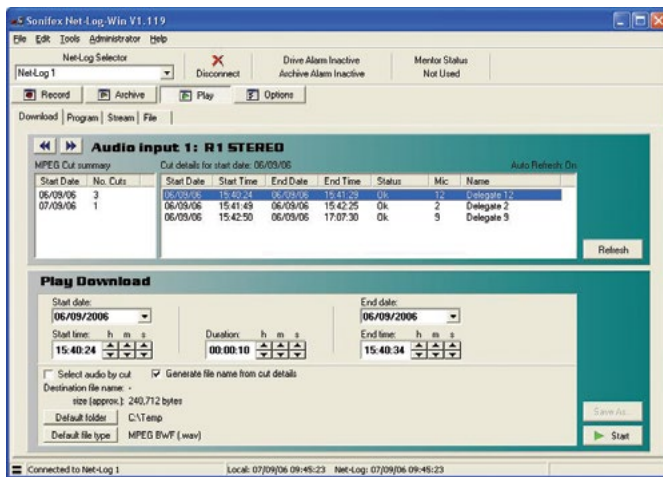

Fig 8-3: Additional Play Cut List Columns

When the Net-Log is powered up with the Televic CE2500 Interface selected, it waits to receive a synchronisation command from the CE2500 before it will execute any further commands. This is to ensure that if any of the microphones are currently activated, and have been previously associated with a record channel, recording is started on the relevant channel. The synchronisation commands are issued by the CE2500 every 5 seconds.

If an attempt is made to stop recording manually in Net-Log-Win on a channel that is associated with an active microphone, a warning message will be displayed in Net-Log-Win.

An alternative method of controlling the recording can be used when using the Televic CE2500 Interface. This is done by utilising the closing contact controlled by the AOP2500 Analogue Output device. This contact is closed when any of the microphones is activated and remains closed until all microphones are deactivated.

By setting all available microphone options to “Disabled” in the Control Options screen, serial control of record start and stop is disabled. Note that the microphone number and name are still recorded in this mode, but because only one closing contact can be used by the AOP2500, only one channel can be recorded, so the microphone number and name are appended to the last recording.

The closing contact on the AOP2500 can then be used to control the remote inputs on Net-Log. See “Record Remotes” in Section 10 for more details on setting up the remote inputs and Section 13 for the pin descriptions of the remote connector.

Televic CE2500 Protocol

The serial settings on Net-Log for the Televic CE2500 interface are as follows:

Serial port:	COM2
Baud rate:	19200
Data bits:	8
Stop bits:	1
Parity:	none
Flow control:	none

The Net-Log responds to 7 of the serial commands issued by the CE2500 unit. These commands share a common structure:

STX ID DATA CRC ETX
where:

STX is the start transmit character ‘%’ (0x25)

ID is a single character which identifies the command

DATA is text associated with the command

CRC is the 16 bit sum of the ASCII chars STX, ID & Data

ETX is the end transmit character (0x0D)

Examples of the 7 commands are as follows:

System Synchronisation

`"%S0001000201D6\r"`

`"%"` is the start of transmit character (0x25)

`"S"` indicates command type

`"00010002"` indicates that mics 1 and 2 are active (0000 for no mics active)

`"01D6"` is the 16 bit CRC

`"\r"` is the end of transmit character (0x0D)

President Microphone Activation

`"%P0001Mr John Smith05A4\r"`

`"%"` is the start of transmit character (0x25)

`"P"` indicates command type

`"0001"` indicates the microphone number

`"Mr John Smith"` is the speakers name

`"05A4"` is the 16 bit CRC

`"\r"` is the end of transmit character (0x0D)

President Microphone Deactivation

`"%p00010131\r"`

`"%"` is the start of transmit character (0x25)

`"p"` indicates command type

`"0001"` indicates the microphone number

`"0131"` is the 16 bit CRC

`"\r"` is the end of transmit character (0x0D)

Delegate Microphone Activation

`"%M0002Mr Joe Bloggs058D\r"`

`"%"` is the start of transmit character (0x25)

`"M"` indicates command type

`"0002"` indicates the microphone number

`"Mr Joe Bloggs"` is the speakers name

`"058D"` is the 16 bit CRC

`"\r"` is the end of transmit character (0x0D)

Delegate Microphone Deactivation

`"%m0002012F\r"`

`"%"` is the start of transmit character (0x25)

`"m"` indicates command type

`"0002"` indicates the microphone number

`"012F"` is the 16 bit CRC

`"\r"` is the end of transmit character (0x0D)

Deactivate All Microphones

`"%V00000116F\r"`

`"%"` is the start of transmit character (0x25)

`"V"` indicates command type

`"0000"` indicates no mics active

`"0116"` is the 16 bit CRC

`"\r"` is the end of transmit character (0x0D)

System Reset (Deactivate All Microphones)

`"%R0052\r"`

`"%"` is the start of transmit character (0x25)

`"R"` indicates command type

`"0052"` is the 16 bit CRC

`"\r"` is the end of transmit character (0x0D)

AMX/Crestron Interface

The AMX/Crestron interface provides simple record control and monitoring for the AMX/Crestron range of Control Panels. These control panels provide a flexible user interface that can be used in addition to the client PCs running Net-Log-Win.

There are no additional configuration options for this interface type. The COM port settings and the protocol commands are fixed.

AMX/Crestron Protocol

The serial settings on Net-Log for the AMX/Crestron interface are as follows:

Serial port: COM2. The serial control interface is implemented on COM2 on Net-Log. Net-Util usually uses COM1 on Net-Log, but when used in Crestron emulation mode, COM2 must be used.

Baud rate: 19200

Data bits: 8

Stop bits: 1

Parity: none

Flow control: none

Operational Note: Flow control is not used. However the Net-Log does assert RTS whenever it has valid characters to transmit. The Net-Util program in Crestron emulation mode asserts RTS all the time. Using Net-Util with the RTS line disabled still works correctly. DCD and DTS are not used. The Net-Log constantly monitors the serial port looking for predefined control characters which signify that a valid command has been received. This control character is set to 0xD (13 decimal) which is the Carriage Return character in ASCII. All data received is buffered internally until this character is received at which point the buffer is closed and validated.

The Net-Log recognises 5 serial commands issued by the AMX/Crestron Control Panel. These commands share a common structure as shown:

CMD DATA NL CR

where:

CMD is the command identifier

DATA is the data associated with the command

NL is the new line character (0x0A)

CR is the carriage return character (0x0D)

The Net-Log issues a reply to all valid commands received. The type of reply depends on the type of command received. For non-data request commands, the reply will either be an acknowledgement or an error code. For data request commands, the reply will consist of the data requested.

Note: The serial commands are case-sensitive.

Speed of Commands & Responses:

The safest and most reliable method of issuing a batch of RS232 commands to the Net-Log, is to send a command and then wait for a response before sending the next command. So for example, if you want to do a status poll of the Net-Log with:

STATUS

TIME:1

TIME:2

TIME:3

TIME:4

you would proceed as follows:

Issue a STATUS command, wait for status info response,

then issue the TIME:1 command, and wait for the time info or error response, then issue the TIME:2 command, and wait for the time info or error response,

then issue the TIME:3 command, and wait for the time info or error response,

then issue the TIME:4 command, and wait for the time info or error response

The response time will depend on other factors, such as number of channels recording and archive and play activity. The RS232 port has a relatively low priority to ensure it does not interrupt critical processes.

Record Start Command

Command: "START:ch\n\r"
 Reply: "ACK\n\r" or "ERR:ee\n\r"
 where: START = command identifier
 ch = channel 1,3 for stereo or 1,2,3,4 for mono
 \n\r = new line(0x0A) and carriage return(0x0D)
 ACK = command accepted
 ERR = command rejected
 ee = error code (see below for error codes)

Record Stop Command

Command: "STOP:ch\n\r"
 Reply: "ACK\n\r" or "ERR:ee\n\r"
 where: STOP = command identifier
 ch = channel 1,3 for stereo or 1,2,3,4 for mono
 \n\r = new line(0x0A) and carriage return(0x0D)
 ACK = command accepted
 ERR = command rejected
 ee = error code (see below for error codes)

Status Command

Command: "STATUS\n\r"
 Reply: "STATE:s1,s2,s3,s4,a1,a2,a3,a4,da\n\r"
 where: STATUS = command identifier
 \n\r = new line(0x0A) and carriage return(0x0D)

STATE: = reply identifier
 s1 – s4 = record channel status 0=not recording,
 1=recording,2=unavailable
 a1 – a4 = archive channel alarm status 0=no
 alarm,1=alarm activated,3=unavailable

Time Command

Command: "TIME:ch\n\r"
 Reply: "TIME:ch,t1,t2\n\r"
 where: TIME = command and reply identifier
 ch = channel 1,3 for stereo or 1,2,3,4 for mono
 \n\r = new line(0x0A) and carriage return(0x0D)
 t1 = length of current recording in dd.hh.mm.ss
 t2 = time to data overwrite in dd.hh.mm.ss

Date Command

Command: "DATE\n\r"
 Reply: "DATE:dd/mm/yyyy hh.mm.ss\n\r"
 where: DATE = command identifier
 \n\r = new line(0x0A) and carriage return(0x0D)
 DATE: = reply identifier
 dd/mm/yyyy = current date of Net-Log in GMT
 hh.mm.ss = current time of Net-Log in GMT

Reply Error Codes

The following error codes are used for non-data request commands (START and STOP):

- 1 = invalid channel
- 2 = disabled channel
- 3 = illegal channel
- 4 = channel already in requested state

9. Options

The Options screens are used for initially configuring the Net-Log before recording. All of the options should be set before Net-Log starts recording, as some of them **can not be altered once recording has started**.

Saving and Loading Options

Once you have finished setting up the options, you can make a copy of them on a PC. This can be particularly useful if you have more than one Net-Log and you want each machine to share a similar configuration.

To save the options for the connected Net-Log, select File, Save As from the main menu. A dialogue will be displayed allowing you to specify the location and name of the file that will be used to store the current configuration information. Once you have made these selections, press Save.

To load a previously saved file, select File, Open and then select the file that contains the required configuration information.

Please note, you can only load and save options whilst in the options screens.

Record Options

This screen (Fig 9-1) displays the current settings of the two input channels, and also allows them to be changed. Each input is independent of the other, although when they are set-up for dual mono recording, the two mono channel record settings cannot be configured individually.

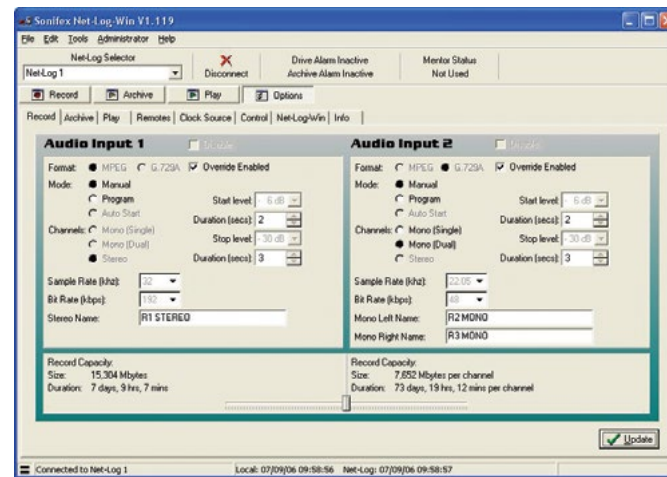

Fig 9-1: Record Options

Disable

Disables the channel.

Override Enabled

Enables this channel to be controlled by the Record Control button on the front of the Net-Log.

Format

Selects the record format, either MPEG or G.729A. Any existing tracks must be deleted from all channels before the record format can be changed. To use the G.729A record format, an additional license must be purchased from Sonifex Ltd.

Mode

In Manual mode, recording is started and stopped via the Record Start button in the record screen.

In Program mode recording is automatically started and stopped according to the program for that particular channel. Note: If the mode is set to Manual mode, the Program record screen will not be available.

In Auto Start Mode, recording is started and stopped automatically as the input audio level passes through threshold level settings. Auto Start mode is not available for channels configured to use the G.729A record format.

Channels

Channel format i.e. stereo, mono or dual mono. For G.729A channels, only mono or dual mono configurations are available.

Sample Rate & Bit Rate

Selects the recording parameters for that Input. These settings are only relevant to MPEG configured channels.

When selecting the recording bit-rates for the two pairs of channels, it is important to refer to the maximum number of network connections in Chapter 3.

Start Level

Defines the auto recording start threshold level in dB. When the input audio level rises above this value, recording automatically starts.

Start Duration

Sets the minimum track length in seconds for auto recording. Tracks that are shorter than this value are automatically deleted.

Stop Level

Defines the auto recording stop threshold level in dB. When the input audio level falls below this value, recording provisionally stops.

Stop Duration

Sets the period of time that the input audio level must stay below the stop threshold level to complete the end of an auto recording. This value is in seconds.

Service Names

You can give names to the particular recording channels for easier identification. These names are displayed on the record, archive and play screens and will also be stored in the MPEG BWF or G.729A header of an archive or download file.

Note that once recording has started on a channel, the record format cannot be changed until recording has stopped and all track(s) have been deleted.

Record Capacity

The slide bar at the bottom of the record options screen allows you to select the hard drive partition size for each input. The partition size is the amount of space allocated to each input for storing audio. The bigger the partition the more space is available, allowing for longer recordings. If an Audio Input is set to Mono (Dual), each mono channel will share equally the space allocated for that input.

The duration of the audio recorded to each partition is calculated and displayed. To change the duration for a fixed partition size using MPEG as the record format, the Bit Rate should be set to a new value. A lower Bit Rate means a longer duration and, conversely, a higher Bit Rate means a shorter duration.

Archive Options

This screen (Fig 9-2) displays the current settings for archiving from the Net-Log. See Chapter 7 for more detailed information.

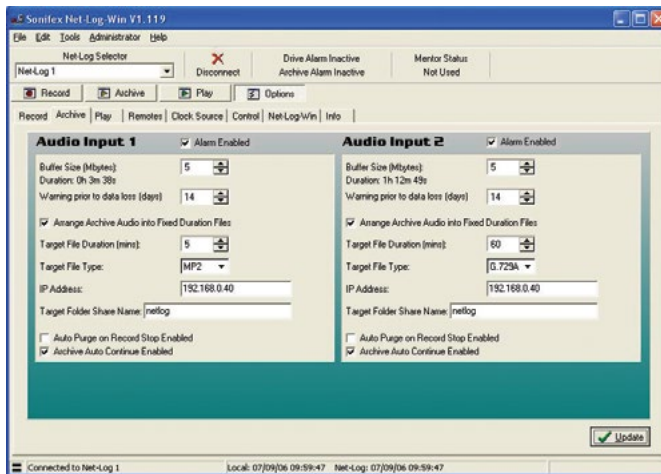

Fig 9-2: Archive Options

Alarm Enabled

Allows data loss warnings and alarms to be disabled.

Buffer Size (Mbytes)

Amount of data that has to be available before archiving can start.

Warn time prior to data loss

Amount of time prior to data loss occurring that a warning is activated.

Arrange Archive Audio into Fixed Duration Files

Formats the archived audio into fixed duration files.

Target File Duration (mins)

The length of the target files. (5 - 60 minutes)

Target File Type

The type of files that are created. The options available for this setting will change depending on the record format selected for this channel.

Destination IP Address

The IP Address of the destination computer.

Target Folder Share Name

The share name of the destination folder on the target computer.

Auto Purge on Record Stop Enabled

Automatically downloads all outstanding audio on a channel when the recording is stopped.

Archive Auto Continue Enabled

Allows the PC running Net-Log-Win to automatically continue archiving on enabled channels.

Note that some of the settings cannot be changed while archiving is active for a channel.

Play Options

This screen (Fig 9-3) displays the current play default settings. These settings apply to the PC currently running Net-Log-Win and are not saved on the currently connected Net-Log.

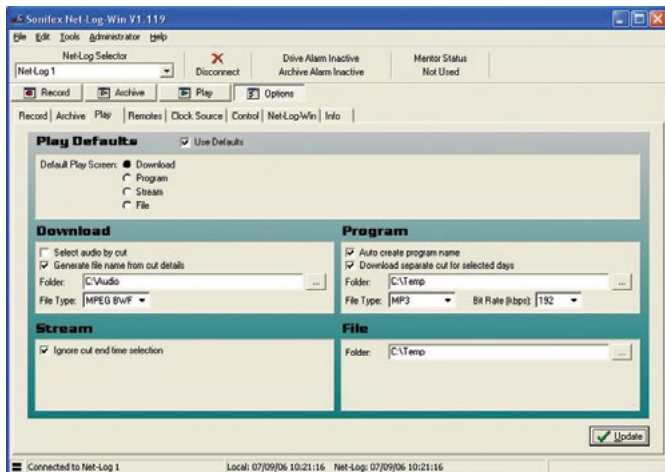

Fig 9-3: Play Options

Use Defaults

Enables all the defaults for play. If this box is not checked, all the defaults are ignored.

Default Play Screen

The selected play screen will be displayed first when entering play.

Play Download Defaults:

Select Audio By Cut and Generate File Name From Cut Details

Enables the corresponding options in the play download screen.

Folder

Selects the default folder where downloaded audio files will be written.

File Type and Bit Rate

Selects the default file type to create, and selects the MP3 bit rate when the file type is set to MP3.

Play Program Defaults:

Auto Create Program Name and Download Separate Cut For Selected Days

Enables the corresponding options in the play program screen.

Folder

Selects the default folder where downloaded audio files will be written.

File Type and Bit Rate

Selects the default file type to create, and selects the MP3 bit rate when the file type is set to MP3.

Play Stream Defaults:

Ignore cut end time selection

Disables selection of the cut end time when clicking on the play stream cut list.

Play File Defaults:

Folder

Selects the default folder for opening audio files in the play file screen.

Remotes Options

This screen (Fig 9-4) displays the current settings of the record remote inputs for the Net-Log. The two pairs of audio input channels can be set-up independently. There are three settings for the remotes, and these are:

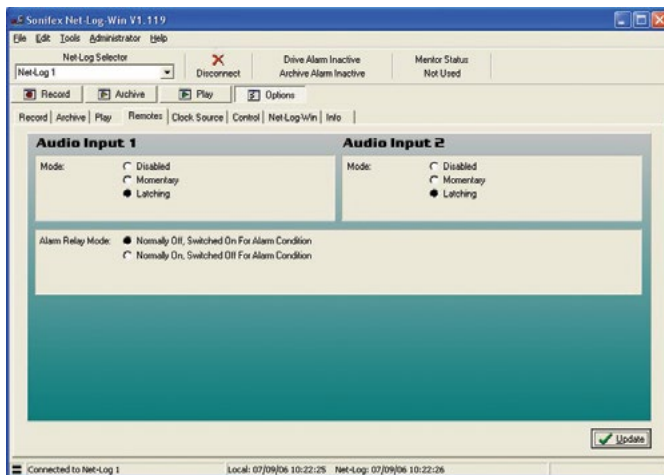

Fig 9-4: Record Remotes Options

Disabled

The remote inputs are disabled for this channel.

Momentary

While the specific pin is connected to ground this channel will be recording.

Latching

Connecting the specific pin to ground for half a second will cause the Net-Log to start recording on that channel. Doing this again will cause it to stop recording.

For information on the remote connector pin connections, please refer to Section 13 - Technical Specifications.

This screen also displays the current settings for the Alarm Relay. The remote connector has a pair of contacts that become connected/disconnected when an alarm condition occurs.

Normally Off, Switched On For Alarm Condition

The contacts on the remote connector are connected when an alarm condition occurs.

Normally On, Switched Off For Alarm Condition

The contacts on the remote connector are disconnected when an alarm condition occurs.

Clock Source Options

When updating the RTC clock, the Net-Log gets it's source from either the clock of the connected PC, or the Sonifex Mentor Server (Fig 9-5). For more information about how

Net-Log uses the time settings see Section 10.

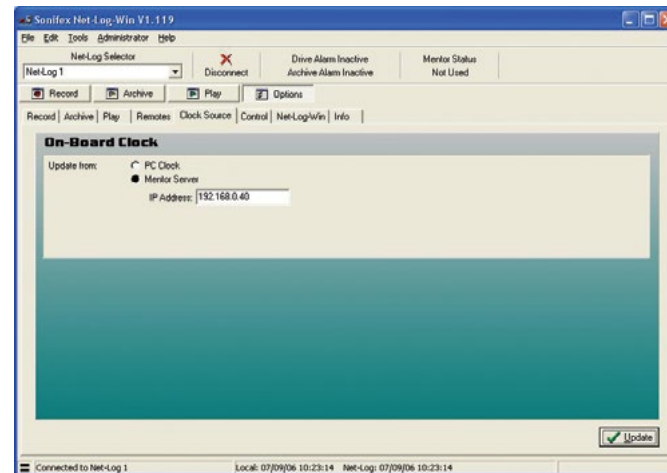

Fig 9-5: Clock Source Options

Control Options

This screen (Fig 9-6) displays the currently selected serial Control Interface. If any additional options exist for an interface, these will be displayed when the relevant type is selected. The current options are:

No Control/Interface Selected

The serial Control Interface is disabled.

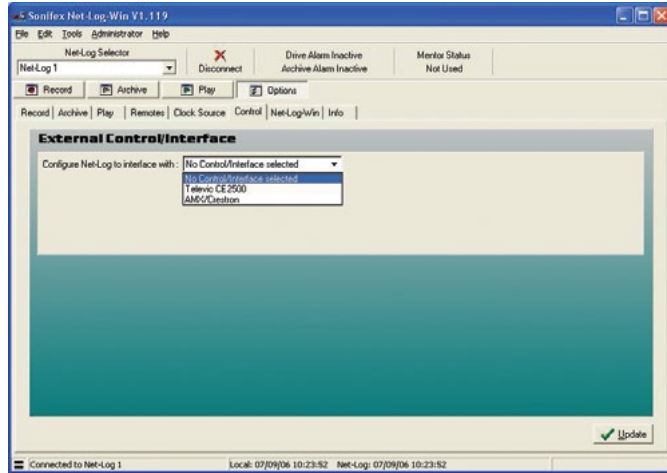

Fig 9-6: Control Interface Options

Televic CE2500

The Serial Control Interface is configured for connection to the Televic CE2500 Digital Conference and Interpretation System. Additional options are displayed for configuring the available record channels to be controlled by specific microphones (see Fig 9-7).

AMX/Crestion

The Serial Control Interface is configured for connection to an AMX/Crestion Control Panel. There are no additional options for this interface type.

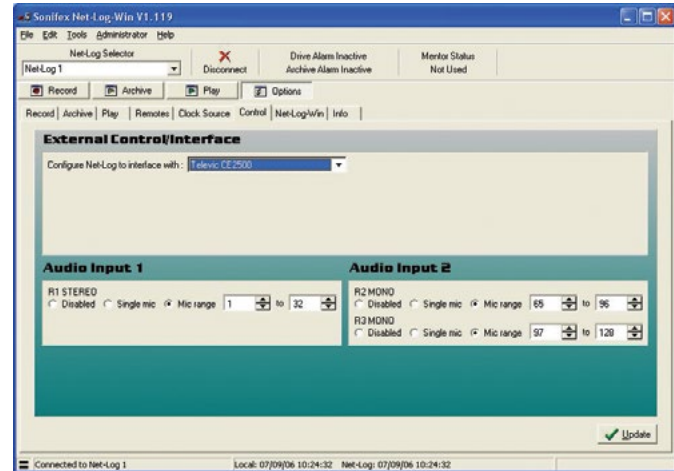

Fig 9-7: Televic CE2500 Control Options

Net-Log-Win Options

This screen (Fig 9-8) displays the options specific to the appearance of Net-Log-Win. Two fonts used in the Net-Log-Win screens can be changed to allow different character sets to be displayed such as Japanese.

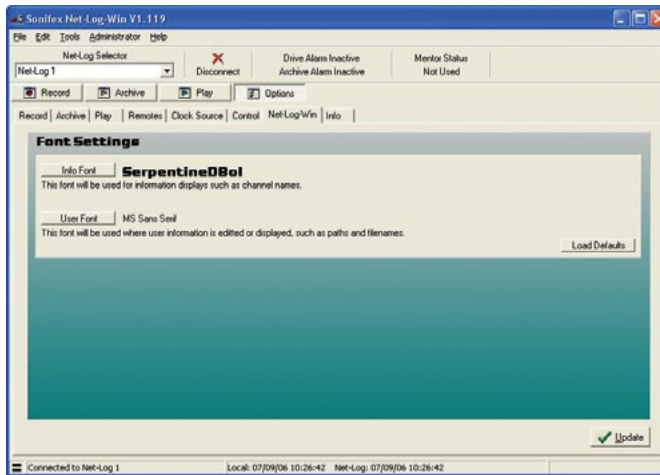

Fig 9-8: Net-Log-Win Options

Info Font

The info font is used to display channel names in the Record, Archive and Play screens.

User Font

The user font is used to display user entered text.

Information

This screen (Fig 9-9) displays general information about the Net-Log. The Network settings are the MAC Address, IP Address, Subnet Mask and Default Gateway for the connected Net-Log. The administrator can change all these settings (except the MAC address) by selecting the Network Settings menu in the administrator menu or by using the Net-Log-Win serial utility, whereby the settings are downloaded to the Net-Log via the serial port. The MAC Address is also stored in the BWF header of an archive or download file.

The Disk Drive Info shows the Model, Serial Number, Firmware Revision and Capacity of the disk drive.

This screen also reports the Remote capability of the Net-Log. Earlier units only had remote input connections on the rear panel mounted the 15-way 'D-Type' connector. These inputs are used to start and stop the recording process remotely. The latest Net-Log hardware has Record Tally Outputs on the 15-way 'D-Type' connector, in addition to the remote inputs, that indicate when the associated channel is recording.

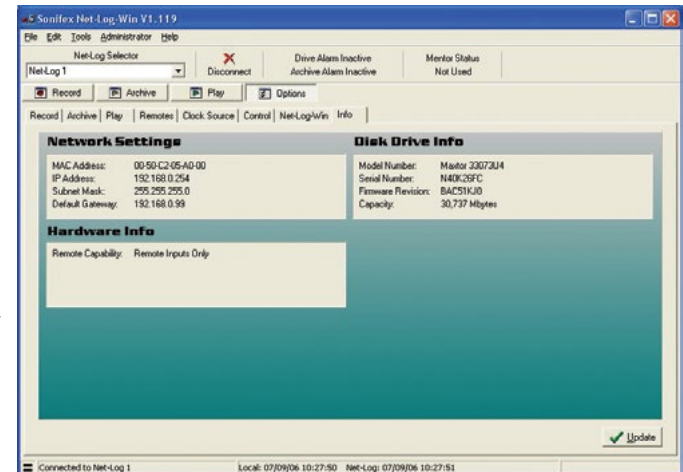

Fig 9-9: Info Options

10. The Administrator

There are several operations that can only be accessed by the administrator. These include the License entry and Accounts editor screens and they are all accessed through the Administrator menu. (Fig 10-1).

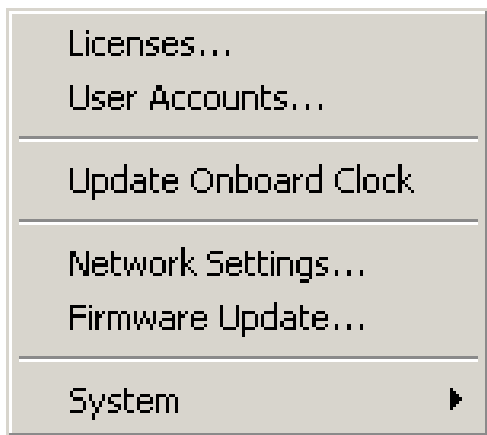

Fig 10-1: Net-Log Administrator Menu

Licenses

This screen displays how many users the Net-Log is licensed for and also allows the administrator to enter more licenses. (See Fig 4-2)

Accounts Editor

The Accounts Editor (Fig 10-2) can be accessed via the Administrator menu option and is used to set-up or change accounts for users who connect to the Net-Log. Below are all the default User Names. Initially the user name and passwords are the same – these can (and should) be altered once the software is running.

“admin”

This is the Administrator’s login. The administrator is in charge of defining user profiles and configuring the settings of the Net-Log.

“user1” to “user25”

Up to 25 users can be defined in the software. Each user can be given different access rights for each function – these are described in more detail below.

“guest”

Guest entry allows playback only.

These password settings are stored on the Net-Log machine currently being connected to, so if you have a number of machines, you can change user access to each machine individually.



Fig 10-2: Accounts Editor

Function Access – View

There are four check boxes associated with this restriction control (Fig 10-3). If checked, the currently selected user will be able to view that specific function but will not be able to change the operation of that specific function in any way.

Note that the administrator will always have view access to configuration and that this cannot be changed.



Fig 10-3: Function View

Function Access – Control

There are three check boxes associated with this restriction control (Fig 10-4). If checked, the currently selected user will be able to view and control that specific function.

Note that only one person can have access to archive control and by default this is the administrator.



Fig 10-4: Function Control

User Name & Password

To change a user name or password, select the user whose details you wish to change and type in a new name or password (Fig 10-5).

Note that all the changes made will only take effect when the “Update” button is pressed. If “Abort” is pressed then the changes are lost.

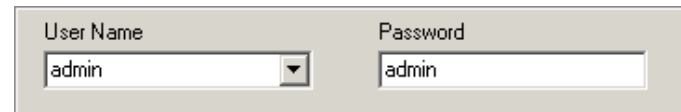

Fig 10-5: Select or Edit User Name & Password

The Onboard Clock

The Net-Log uses an accurate onboard real time clock (RTC) to record the start & stop times of cuts and to start & stop record programs. This time is stored on the Net-Log in UTC format which is identical to Greenwich Mean Time and is unaffected by any summer or daylight saving time schemes.

The accuracy of the RTC is ± 1.53 minutes per month. This equates to about 3 seconds per day. During long or continuous recordings, an error can develop between the actual time a piece of audio is recorded, and the time used from the RTC to reference the cut. In a worst case scenario, when the RTC is running slightly slow with respect to real time, the audio at the end of a long recording could be unavailable. This is because the time stamp taken from the RTC for the end of the cut would be earlier than the actual time the cut ended. To overcome this, the Net-Log firmware determines whether the RTC derived time for the end of a recording differs from the time the Net-Log calculates the cut should end at. This calculation is made using the start time and length of the recording. Future play or archive accesses to this cut will then use this error figure to bias the search calculation so that the whole cut is accessible.

If the RTC has drifted, then the start time of any new cuts will not be a true reflection of the actual time the recording was started. If the start time for a recording is inaccurate, the time displayed when playing the recording and when searching within it will also be inaccurate. Also, if program record mode is used, the automated record starts/stops will not happen at exactly the right time. It is important therefore, to regularly update the RTC if accurate audio to time synchronisation is required.

Updating The Onboard Clock

The onboard clock can be updated at any time. If an update occurs whilst a channel is recording, and the difference between the current RTC and the time update is greater than two seconds, the recording will stop prior to the clock update. Once the clock has been updated, a new recording will automatically begin. This is done to reduce the error correction required

when searching for audio. It also happens so quickly that you will not lose any audio. However there will be a time difference between the two recordings.

There are two options for RTC clock updates. The first is to update Net-Log with the time currently set on the connected PC. This is an administrator only function and it is not automatic. The second option is to automatically synchronise the onboard clock to a specific PC using the Mentor software. It is advisable to have the clock on the PC running the Mentor server accurately maintained from an external source. The Mentor software will then distribute the time information to multiple Net-Logs every 30 minutes.

Whichever update method is used it is very important that any PC used to connect to Net-Log is set for the right Time Zone. Otherwise, the conversion between UTC and local time that Net-Log-Win performs for all time related data, will be incorrect. This is set in the PC Control Panel setting for Date/Time.

It is possible to force a clock update for either of the two clock options by selecting the Administrator menu (Fig 10-1), and then Update Onboard Clock. If you are using the PC clock option and you want to keep the Net-Log clock accurate to within 10 seconds, you will need to do this every 2-3 days.

Network Settings

To change the Network Settings of the Net-Log simply enter the administrator menu and select the Network Settings menu. The screen (Fig 10-6) shows the current settings and next to these are a series of edit boxes where the new settings should be typed. When they have been entered simply press the "Update" button, the settings will then be downloaded to the Net-Log and the application will shut down. Once the Net-Log has re-initialised with new settings you can restart Net-Log-Win. You may need to change the IP Address of the unit in the device editor before you can attempt to log onto the Net-Log.

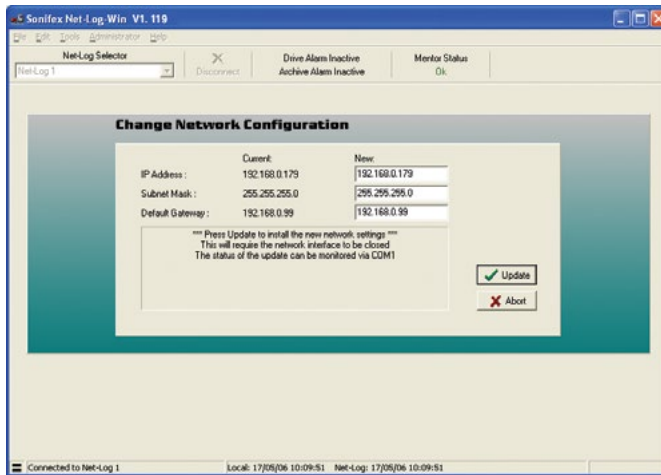

Fig 10-6: Network Settings

Updating Firmware

From time to time updates will be made available to keep the Net-Log running smoothly and reliably. To update the firmware contained in the Net-Log simply select the “Firmware Update” option in the Administrator menu, you will then be given a warning and asked to confirm your action. If “Ok” is pressed, you will then have to select the update file (.dwn suffix). Once this has been done you will be taken to the Net-Log Update Firmware screen. Press the “Transfer” button and the file will then be transferred onto the hard drive contained on the Net-Log (Fig 10-7).

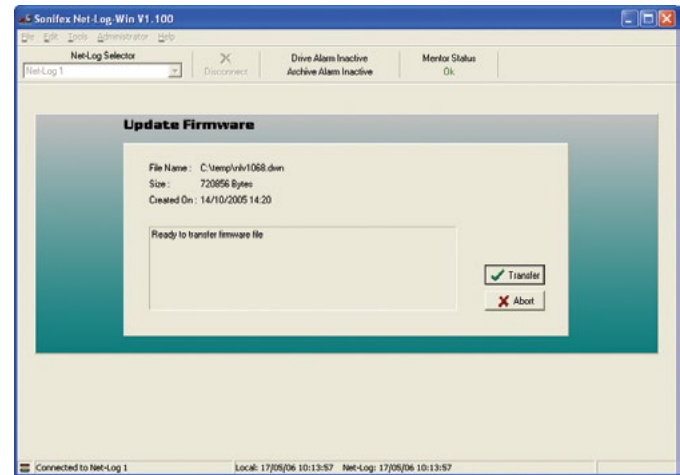

Fig 10-7: Upgrading Firmware

Please note that you can still abort the update even after the transfer has been completed. To commence the actual update, press the “Transfer” button again. The System ROM is then erased and programmed with the updated software (shown by the Record Control button on the front of the Net-Log being lit), after which the Net-Log will restart and is ready for use again. Note that updating the firmware can also be done using the Net-Log serial utility.

For the latest firmware updates check the Sonifex website at www.sonifex.co.uk.

Sometimes, updating the firmware can result in the loss of audio data depending on which firmware version you are upgrading from/to. Information on this is also on the website.

Resetting The Net-Log

This option is a sub menu of system in the administrator menu. This is used to restore all the configuration settings to factory defaults. It also deletes all the tracks contained on the Net-Log.

11. Tools

The Tools menu (Fig 11-1) contains a number of useful tools to check on the performance and status of the Net-Log unit. There is also a Delete Cuts sub-menu, although this is only available to users who have record access.

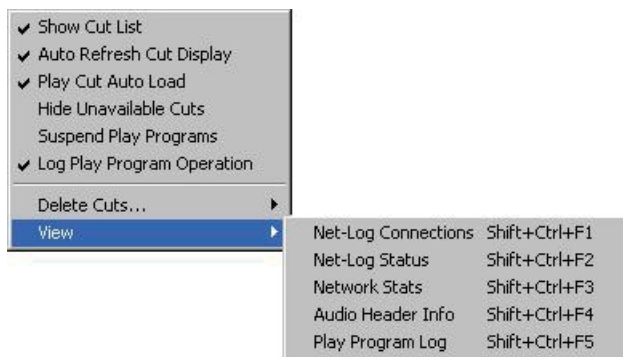

Fig 11-1: Net-Log Tools Menu.

Show Cut List

When this option is not ticked, the cut list display in the play screens is hidden. This option is ticked by default.

Auto Refresh Cut Display

With this option ticked, the cut displays in the Play screen will automatically refresh when a recording is started or stopped, or when you change to a different channel.

Play Cut Auto Load

When this option is ticked, the details of the first recording for the selected Start Date will automatically be loaded into the current Play screen (Play Download or Play Stream).

Hide Unavailable Cuts

When this option is ticked, all recordings that are no longer available due to being over-recorded are hidden from the Play screen cut list.

Suspend Play Programs

When this option is ticked, the execution of Play Programs is halted. Any program download that is currently active will be completed but no further downloads will start.

Log Play Program Operation

When this option is ticked, information about the progress of Play Program downloads is written to a log file. Information includes details about when a download is completed, as well as information on any errors that were encountered during the program, such as failure to locate the selected audio.

Deleting Cuts

This menu option does exactly what it says. When you select this option a sub-menu appears showing all the channels that you are able to delete cuts from. Note that you can only delete cuts from a channel if this channel is not currently recording. The Delete All option automatically deletes all cuts from all non-recording channels.

View

Contained in this menu are five sub-menus. Net-Log Connections, Net-Log Status, Network Stats, Audio Header Info and Play Program Log. Each of these display information about Net-Log's performance and status, and are described in more detail below.

Net-Log Connections

This useful screen (Fig 11-2) displays all users currently connected to Net-Log, and displays their IP Address and connection duration.

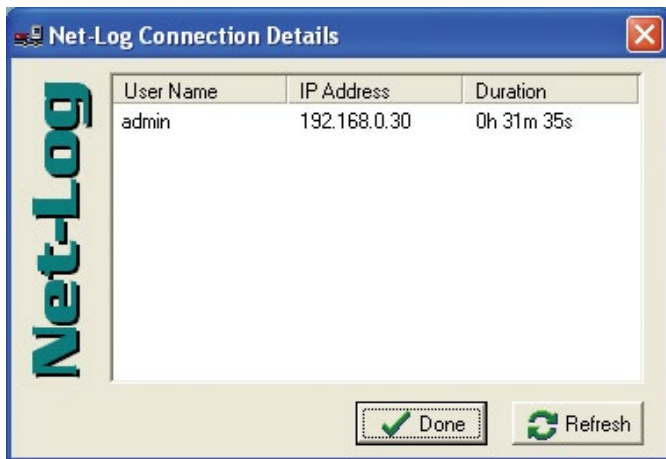

Fig 11-2: Net-Log Connections Screen

Net-Log Status

This screen (Fig 11-3) displays the status of the Net-Log and All the Input Channels. Described over leaf are all the status indicators.

Drive Alarm

Problem writing to the Disk. (Equivalent to the LED on the front panel). This Alarm is cleared only once the fault has been rectified.

The next 3 indicators give momentary indication of a change in state of the appropriate feature

Cut Change

Indicates a recording start/stop or cuts being deleted.

Program Change

Programs have been changed.

Config Change

Configuration settings have been changed.

Record Auto Enabled

Auto record mode is enabled on the specified channel.

Record Active

Net-Log is currently recording on the specified channel.

Archive Enabled

Archive is enabled on the specified channel.

Archive Pending

Net-Log has data ready to archive for the specified channel but Archiving is not enabled.

Archive Auto Purge

Archive will transfer all available audio data for the specified channel.

Archive Active

Data is currently being archived from the specified channel.

Archive Warn

Loss of data is about to occur on the specified channel.

Archive Alarm

Loss of data is has occurred on the specified channel.

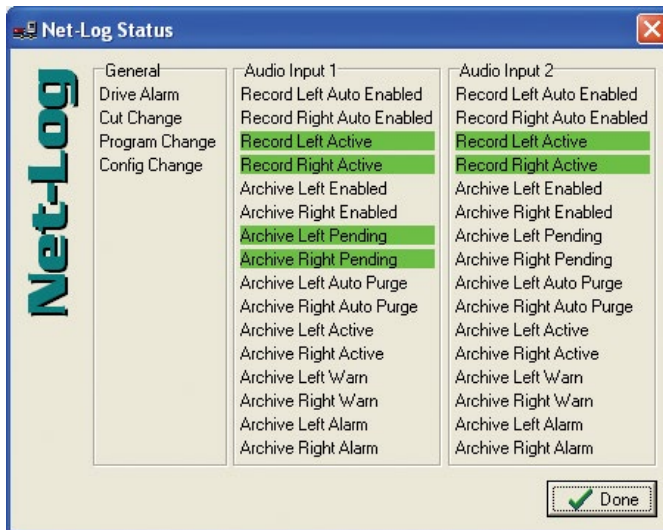

Fig 11-3: Net-Log Status Screen

Network Stats

This screen (Fig 11-4) displays the rate of transmission between the Net-Log and connected Client, and also displays the status messages transmitted to and from the Net-Log. This is useful for network traffic monitoring.

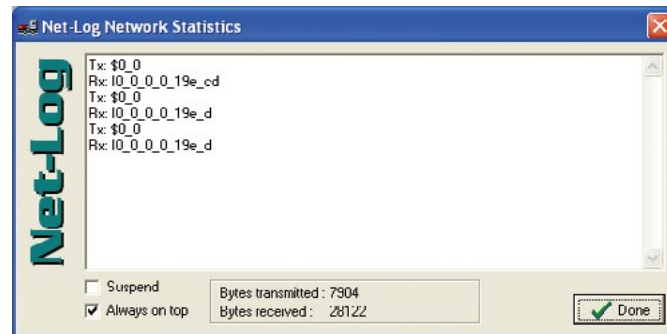

Fig 11-4: Net-Log Stats Screen

Audio Header Info

This screen (Fig 11-5) shows detailed information about the audio cuts on the selected Net-Log. It is mainly for debugging purposes.

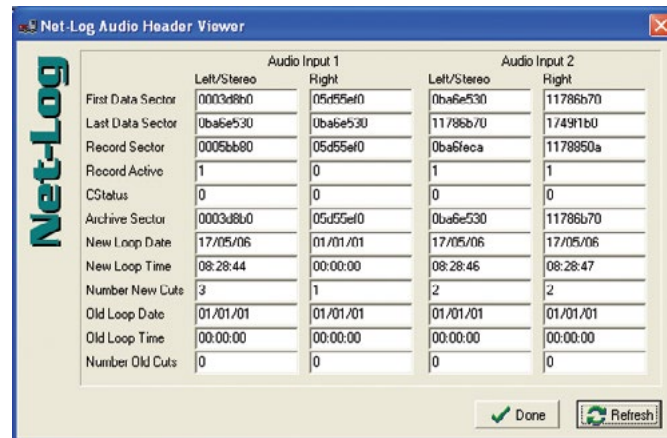

Fig 11-5: Net-Log Audio Header Info Screen

Play Program Log

This screen (Fig 11-6) shows information on the progress of any Play Programs that have been executed. Its main use is to determine the cause of any errors that were encountered.

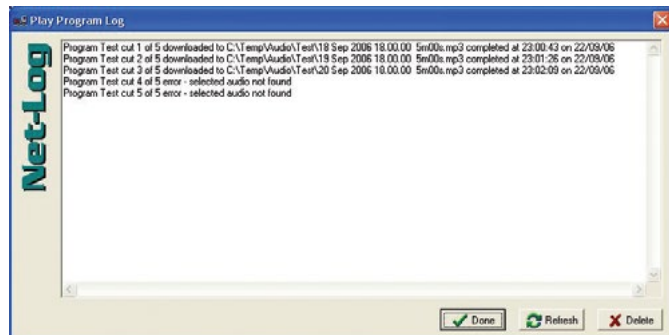

Fig 11-6: Play Program Log Screen

About Sonifex Net-Log

This screen (Fig 11-7) accessible from the help menu shows the software versions of the Net-Log-Win and the currently connected Net-Log. The current status of the License on the currently connected Net-Log is also shown here. The information on this screen is mainly used for debugging and version checking.



Fig 11-7: Net-Log About Screen

12. Auto-Archive

Introduction

Auto-Archive can be used to archive audio, control the recording process and schedule recording of up to twenty Net-Log units simultaneously. Using Net-Log-Win to archive material from a Net-Log unit to a PC/Server requires a user to manually log-on to the Net-Log, initiate archiving and remain logged-on for the duration of the archive process. Whilst this is satisfactory for most set-ups with one Net-Log unit, a more automated solution is required for installations of two or more Net-Log units. Net-Log Auto-Archive can be used with up to twenty Net-Logs simultaneously, automatically logging-in, archiving the available material and logging-out.

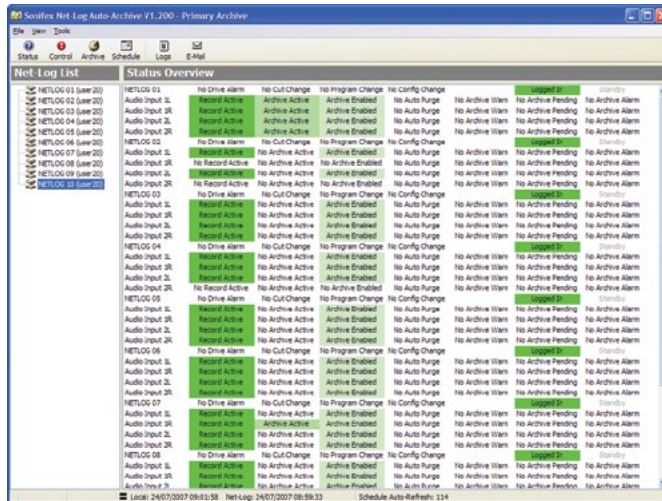

Fig 12-1: The Status Screen

Licensing

When connecting to a Net-Log unit, an available stream license is required to perform the archiving process.

Using Net-Log-Win, it is suggested that a user (such as User20) is defined as having 'Archive Control' and 'Record Control', but no 'Play Control'. Auto-Archive will then only use one stream license when connected to a Net-Log unit.

When Auto-Archive logs on to the Net-Log, it uses one of the user accounts to do this. See "The Settings Screen" later in this chapter for information on defining the User Name used for auto archiving.

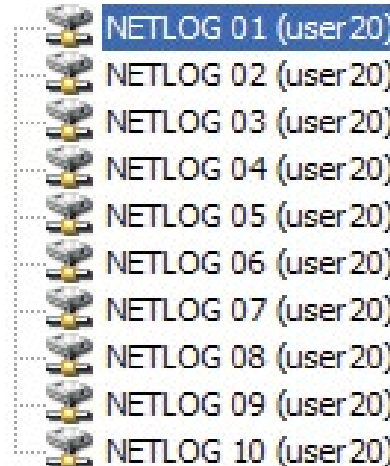

Fig 12-2: The Net-Log List

The Net-Log List

The Net-Log Auto-Archive screen displays the defined list of Net-Log units down the left side. When a particular unit has been logged-on, the User Name is displayed in brackets. See Fig 12-2. This list can be edited by selecting Tools from the main menu, and then selecting Settings.

The Status Bar

The status bar has transmit (Tx) and receive (Rx) indicators, which can be viewed to confirm the connection to the selected Net-Log.

Performance

Please note that the performance of Auto-Archive depends upon the network and PC architecture, number of Net-Log units and the bit rate of the archives being created.

System Set-up

Net-Log units are equipped with 10mb/s network interfaces that should be connected directly to a 10/100 or 10/100/1000 capable Ethernet switch. The archiving PC/server should be fitted with at least a 100mb/s network interface. If possible use a 1000mb/s network interface, especially if multiple Net-Logs are being archived with high bit rates (e.g. 384kb/s stereo, or 192kb/s mono).

Starting The Archive

Before the archive process can begin, the Auto-Archive utility has to Login to the Net-Log(s). This is achieved in one of two ways. To manually connect to a Net-Log, right click on the Net-Log name on the left side on the screen and then select Connect. Once a connection has been established, and the archive rights of the account used to logon to the Net-Log has been confirmed, archiving can begin. Auto-Archive will then stay connected to the Net-Log until it is manually disconnected. To do this, right click on the Net-Log name and select Disconnect. For a more automated setup, Auto-Archive can be set to automatically Login to the configured Net-Logs, check for and archive outstanding audio, and then Logout. See the Auto Login/Logout option in the Device List later in this chapter for details.

The Settings Screen

To access the Settings screen, select Tools from the main menu, and then select Settings. The screen shown in Fig 12-3 will be displayed.

Device List

Define your list of Net-Log units using the 'Add', 'Replace', and 'Delete' buttons. To fully automate the archive process, select the Auto Login/Logout checkbox to allow Auto-Archive to automatically login to each configured Net-Log at regular intervals and archive outstanding audio. This option must be set individually for all required Net-Logs.

To enable successful archiving on each Net-Log, be sure to use the User Name and password that has 'Archive Control' rights.

When connecting to a Net-Log unit, an available stream license is required to perform the archiving process.

Using Net-Log-Win, it is suggested that a user (such as User20) is defined as just having 'Archive Control' and no 'Play Control', and this user used by Net-Log Auto-Archive.

See chapter 10 for more information on licensing and users and rights.

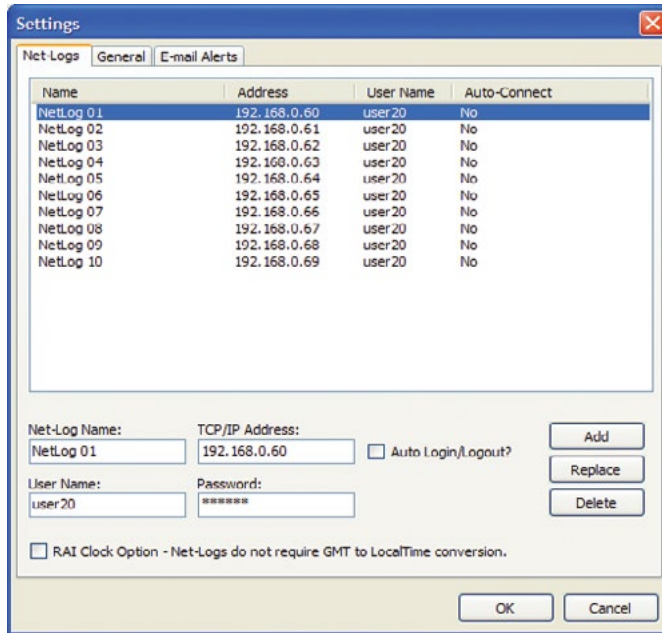

Fig 12-3: Net-Log Device List

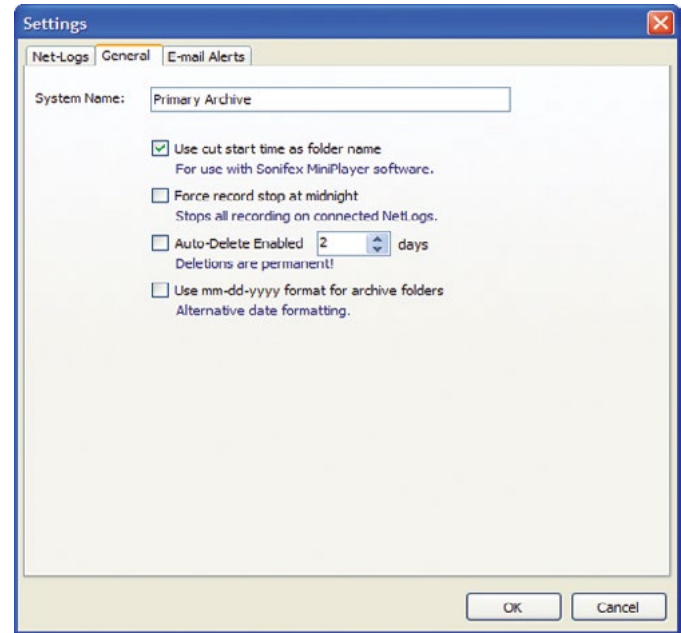

Fig 12-4: The Settings Screen

System Name

Enter a meaningful name to describe this particular system. This name will appear in the applications caption bar and any emails sent from this system. This can be especially useful if two or more Auto-Archive systems are in use.

Force Record Stop at Midnight

With the force stop option checked all recording channels will be forcefully stopped at midnight. This feature requires Auto-Archive to be logged-in to the Net-Log units over the turn of midnight.

Auto-Delete Archives

If Auto-Delete is enabled, previously archived material will be deleted after the specified number of days.

Use mm-dd-yyyy Format for Archive Folders

Check this option if you require the archive folder names to use the mm-dd-yyyy format and not the default dd-mm-yyyy format.

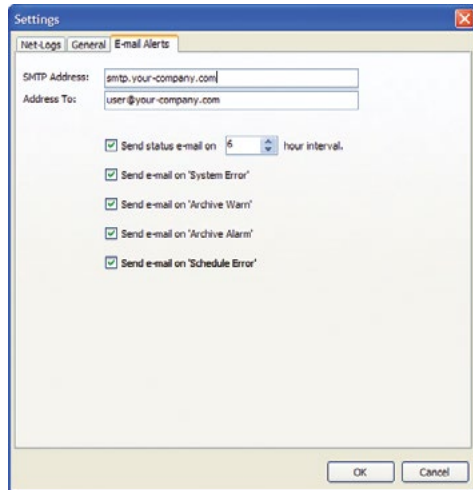

Fig 12-5: The Settings Screen

E-Mail

These options are used to configure the sending of the e-mailed status reports.

- SMTP Address – TCP/IP address of your e-mail server.
- Address To – E-mail address of recipient. Must contain only one address and in the format: user@your-company.com
- Interval – Interval (in hours) between sending of Status Reports. Suggest setting this between '6' and '24' hours.
- E-mail Status Report – option to send/not send Status Reports.
- E-mail Error Report – option to send/not send Error Reports.
- E-mail 'Archive Warn' – option to send/not send 'Archive Warn' reports.
- E-mail 'Archive Alarm' – option to send/not send 'Archive Alarm' reports.
- E-mail 'Schedule Error' – option to send/not send 'Schedule Error' reports.

See later in this chapter for a description of these reports.

The Status Screen

The Status screen displays the current known status of each defined Net-Log unit.

See Fig 12-6.



To view the Status Screen, press the 'Status' button on the toolbar.

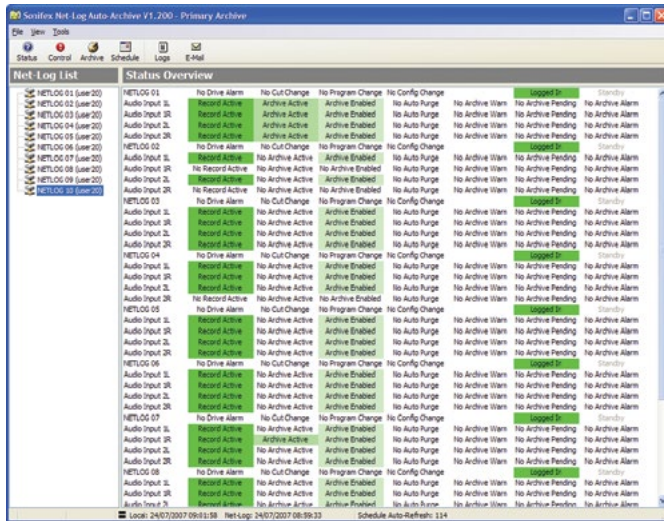

Fig 12-6: The Status Screen

If auto-login and/or auto-logout are enabled, this screen also shows the login and log-out countdown timers for each Net-Log unit.

The Control Screen

The Control Screen can be used to start and stop recordings, and also start and stop the archive process on each of the designated Net-Log units. See Fig 12-7.

Archive LED states:

- Flashing Yellow : Archive Pending
- Steady Yellow : Archive Active
- Flashing Red : Archive Warn

- Steady Red : Archive Alarm
- Off : No Archive Pending

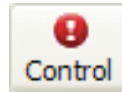

To view the Control Screen, press the 'Control' button on the toolbar.

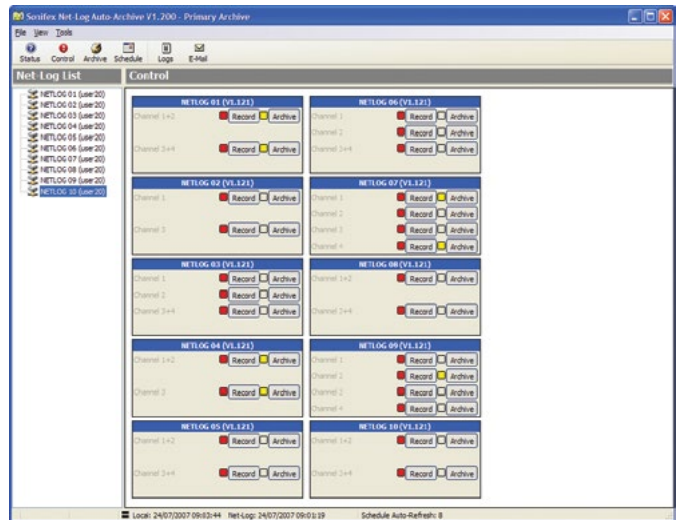
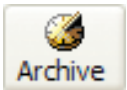

Fig 12-7: The Control Screen

The Archive Screen

The Archive Screen can also be used to control the archive process of the currently selected Net-Log. See Fig 12-8.

This screen also shows record parameters, archive settings and displays the filenames of archives currently being written to disk. See Chapter 9 on the use of the Archiving settings.



To view the Archive Screen, press the 'Archive' button on the toolbar.

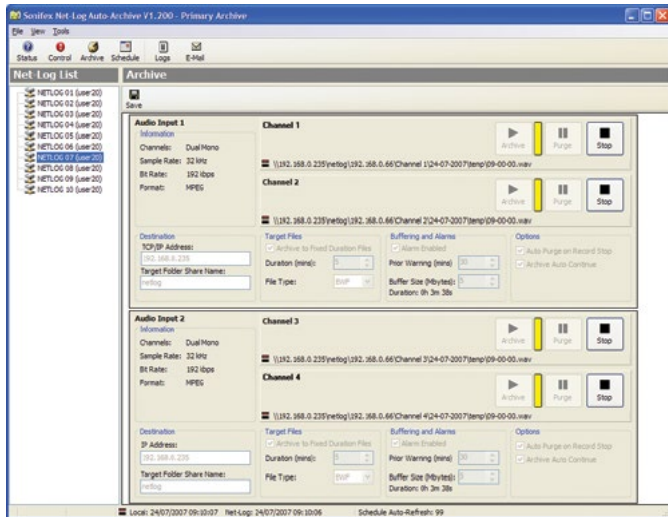

Fig 12-8: The Archive Screen

The Event Log Screen

The Event Log Screen lists noteworthy events in chronological order. See Fig 12-9.

Such events include:

- connections/disconnections with Net-Log units
- important information regarding failure to properly archive material
- confirmation of sent email reports



To view the Event Log Screen, press the 'Log' button on the toolbar.

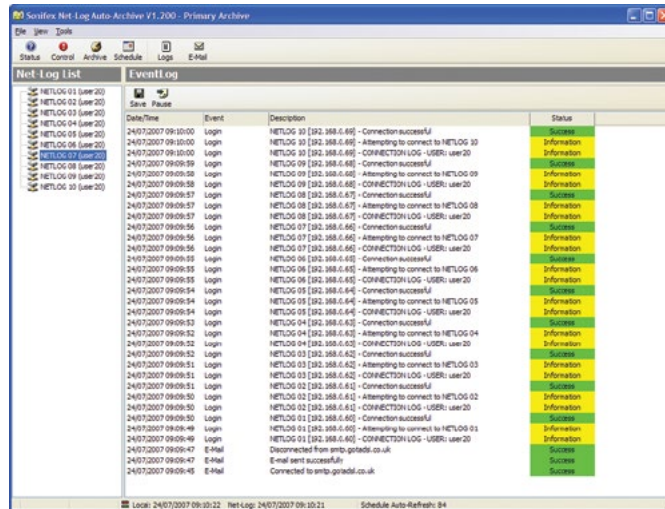

Fig 12-9: The Event Log Screen

Reports

There are a number of e-mailed reports available from Net-Log Auto-Archive.

Status Report

The general Status Report includes information regarding the known current state of all defined Net-Log units, including Login/logout timings and audio input status.



This report can be generated manually by pressing the 'E-Mail' report button on the toolbar.

Error Report

Error reports are generated when a communication error has occurred with a single Net-Log unit. The error type will be included within the report. Whilst some of these errors will be critical (such as 'Connection Error'), some are not (such as 'User Unavailable')

Possible Errors

- 'Invalid User Name' – User Name is not recognised by Net-Log unit. Check Options.
- 'Invalid Password' – password is not recognised by Net-Log unit. Check Options.
- 'User Unavailable' – user is already logged-in. Check connected users with Net-Log-Win.
- 'No/Bad Response' – connection broken. Check network cabling.
- 'No Valid Licenses' – Net-Log has not been licensed. Use Net-Log-Win to issue a license.
- 'Valid licenses in use' – all licenses are in use.
- 'Connection Error' – unable to connect to Net-Log. Check network cabling.
- 'No Disk Space!' – archive target has no useable space remaining. Change archive destination or make some space available.

Archive Warn Report

'Archive Warn' reports are generated when a Net-Log input channel is about to overwrite material that has not yet been archived. This usually happens when the input channel has not been 'Archive Enabled'.

Archive Alarm Report

'Archive Alarm' reports are generated when a Net-Log input channel is overwriting material that has not been archived. This usually happens when the input channel has not been 'Archive Enabled'.

Startup/ Shutdown

Auto-Archive automatically sends a confirmation email whenever the application is started or closed.

The Schedule

From version 1.200, Net-Log Auto-Archive can be used in conjunction with the Sonifex Net-Log Scheduler application (see Chapter 13) to start and stop scheduled recordings on up to twenty Net-Log units.

The Schedule Database

The schedule is stored within a local Microsoft Access database file called 'schedule.mdb' and can be found in the 'c:\program files\sonifex\net-log auto-archive\schedule' folder.

Network Scheduling

If you plan to use the Net-Log Scheduler application on a different computer to that of Net-Log Auto-Archive, then the folder where the schedule database is stored needs to be shared.

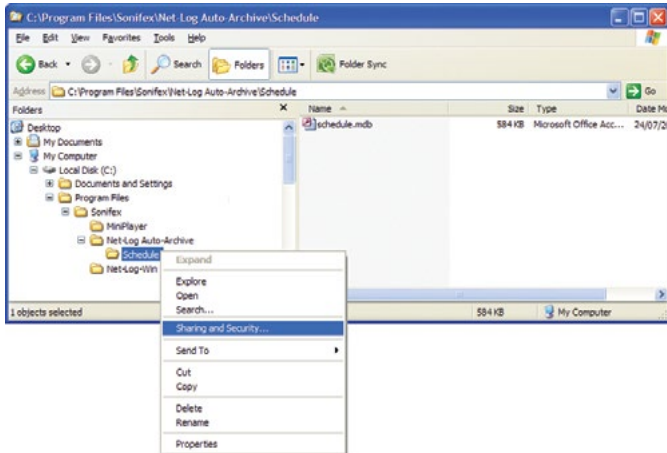
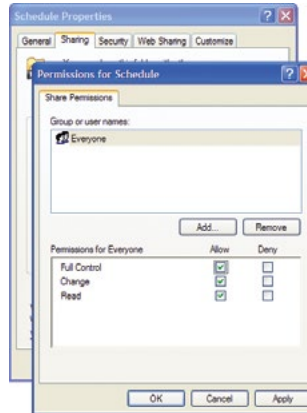

Fig 12-10: Sharing and Security Selection

Locate the 'c:\program files\sonifex\net-log auto-archive\schedule' folder using Windows Explorer, right-click and select 'Sharing and Security' from the menu.



In the 'Permissions for Schedule' tab check 'Full Control' to 'Everyone'. Then press the 'OK' button.

Fig 12-12: Permissions Screen



In the 'Schedule Properties' tab, select 'Share this folder' as 'Schedule'. Then press the 'Permissions' button.

Fig 12-11: Schedule Properties Screen

The Schedule Screen

The scheduling feature of Net-Log Auto-Archive can only be accessed if the computer has a Sonifex D:Scribe Server dongle fitted.



Fig 12-13: D:Scribe Dongle

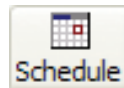

To open the Schedule Screen, press the 'Schedule' button on the toolbar, or select 'View->Schedule Screen' from the menu.

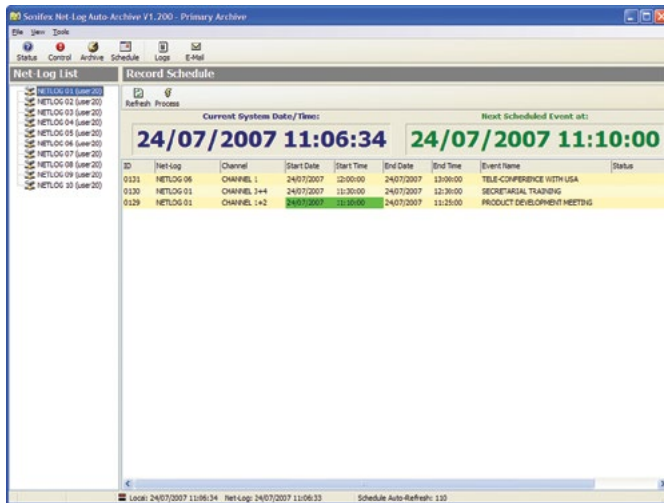

Fig 12-14: Primary Archive Screen

The Schedule Screen shows a list of current and passed scheduled recording events. Auto-Archive cannot be used to add to, edit or remove events from the schedule, this can only be accomplished through the Net-Log Scheduler software.

Auto-Archive can only successfully start and stop recordings from the schedule when the required Net-Log is online and logged-in with a user of sufficient rights to the record process.

13. Net-Log Scheduler

Introduction

The Net-Log Scheduler application is used in conjunction with Net-Log Auto-Archive to schedule recordings on upto twenty Net-Log units.

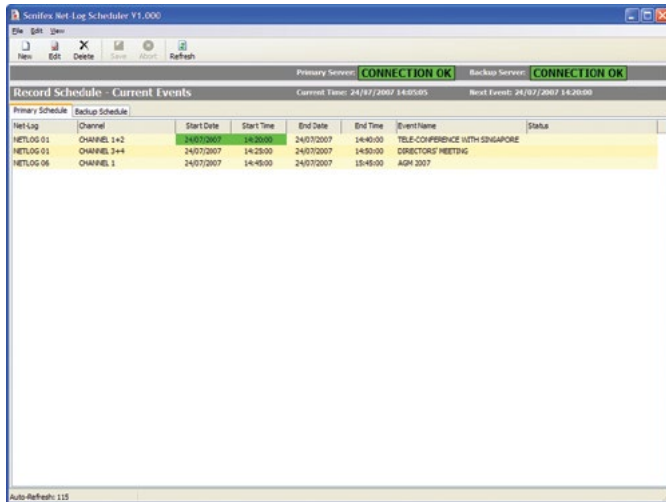

Fig 13-1: Net-Log Scheduler's Listing

The user can add new events, edit existing events, and delete events from the schedule. The schedule listing is automatically refreshed every two minutes to show additions and changes that may have been made from another computer. Alternatively, the listing can be refreshed manually by pressing the 'Refresh' button on the toolbar.

Database Connection Status

The status of the connections to the two databases is displayed at the top of the window. Each status indicator should read "CONNECTION OK", but could read "FAILURE" in the event of server or network failure / maintenance.

Primary and Backup Schedules

The Net-Log Scheduler application can be configured to use up to two databases on separate Auto-Archive computers. This arrangement can be used as a primary and a backup system.

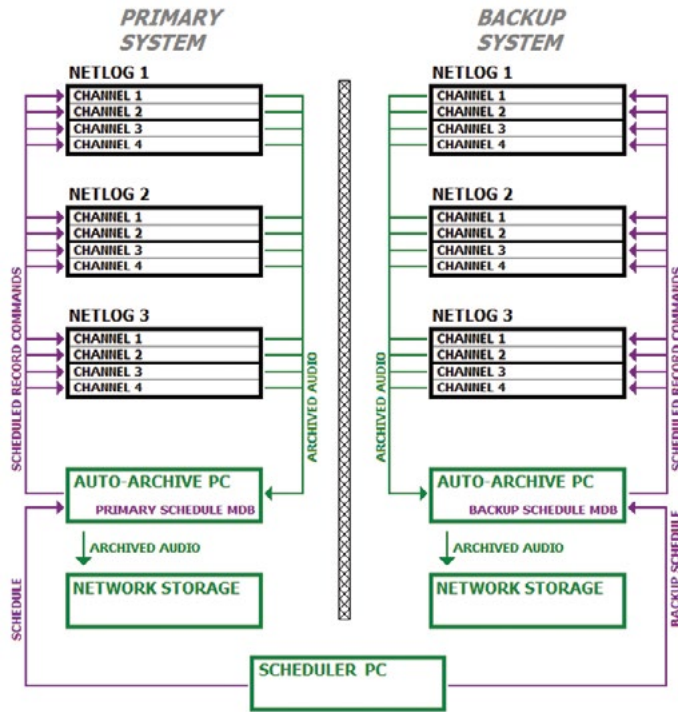

Fig 13-2: Block diagram showing two mirrored systems for use as primary and backup

The list of available Net-Log units and their channels is derived from each Net-Log Auto-Archive in the system. Each Auto-Archive should name its corresponding Net-Log units identically to those Net-Logs in the opposite system which have the same function.

Database Locations

To select the primary and backup database locations, select 'View->Settings' from the menu.

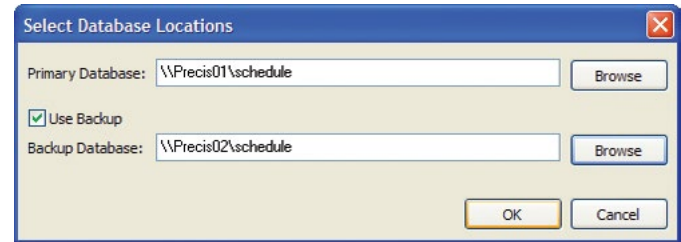

Fig 13-3: Selecting Database Locations

Enter the location of the primary database or use the browse button to search the local PC or the network.

If you are also using a backup recording and archiving system check the 'Use Backup' option and browse for the location of the backup database.

Create a New Event

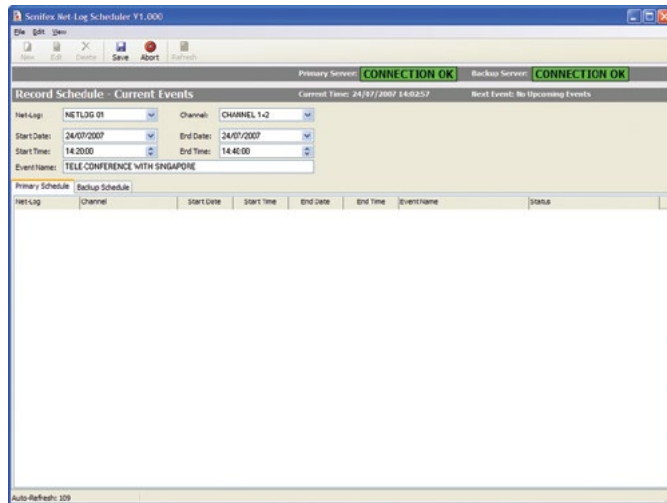

Fig 13-4: Entering a New Schedule Recording

To schedule a new recording, click on the 'New' button or select 'File->New' from the menu.

Select the appropriate Net-Log and Channel to record, and enter the correct start date/time, end date/time and give the recording a meaningful name.

After pressing the 'Save' button on the toolbar, the schedule listing will be updated with the new event.

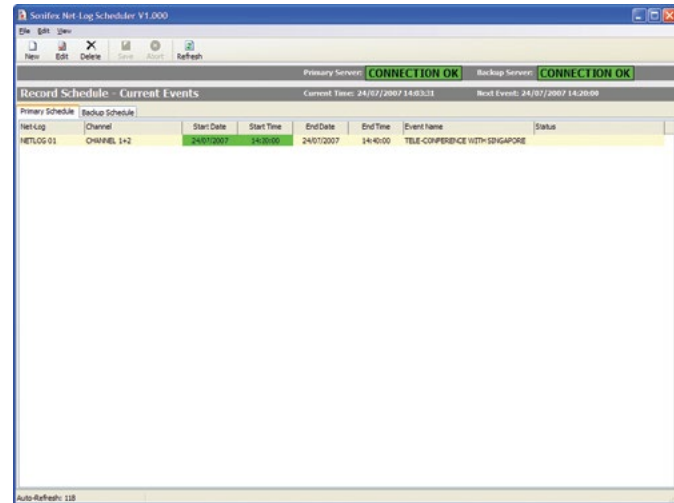

Fig 13-5: Updated Listings with a New Recording

Once a number of recordings have been scheduled, the list can be sorted by clicking on the column headings. The date/time of the next start/stop event is highlighted in green.

Once a scheduled event has expired (passed the stop date/time) the event is low-lighted. After seven days, the item is removed from the Current Events list and is placed in a Historic Events list. The lists can be viewed by selecting the appropriate item from the 'View' menu.

There is no limit to the number of recordings that can be scheduled. Although, it is recommended that events are manually deleted from the Historic Events list periodically to ensure system stability.

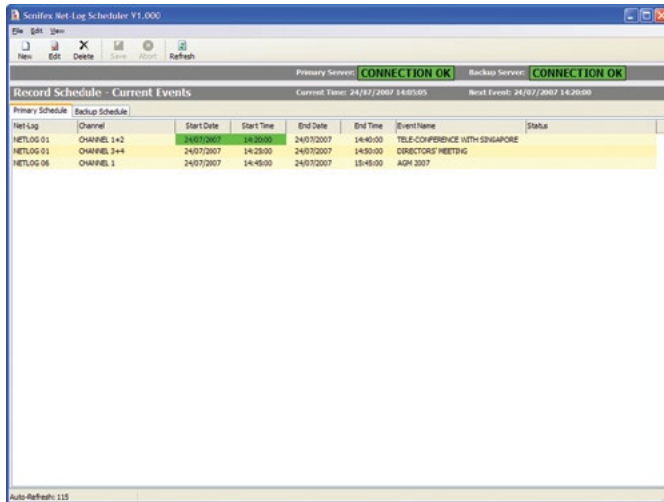

Fig 13-6: A Schedule List Showing Multiple Recordings

Refreshing the Schedules

The primary and backup schedules automatically refresh every 2 minutes. To force a refreshed view of the schedules, press the “REFRESH” button.

14. Technical Specification

Physical Specification

External Dimensions:	1U 19" rack X 220mm deep
Net Weight:	2.5kg
Gross Weight:	3.5kg

Audio Specification

Input Impedance:	>10kΩ balanced
Input Gain Range:	-6dBu to +20dBu ref. full scale digits
Maximum Input Level:	+20dBu
Distortion:	<0.1% @ 1kHz +16dBu
Signal To Noise Ratio:	90 dB RMS a wtd. 22kHz bandwidth
Wow and Flutter:	Un-measurable
Phase Error at 10kHz:	Un-measurable

Please note that the audio specification of the play output depends on the soundcard that you have installed in your PC. Net-Log is a recording device and has no audio output of its own.

Rear Panel Connections, Controls and Indicators

Analogue Inputs (4):	XLR 3 Pin socket
Input Level Controls (4):	Rotary pre-set potentiometers
Network:	RJ45 (10BaseT) and BNC (10Base2) 10Mbps Ethernet
Network Status LED's:	Rx, Tx, link and collision
RS232 (2):	9 way D-type plug

Alarm Outputs and
Remote Inputs/Outputs: 15 way D-type plug

Power: IEC Power Plug, 95-265 VAC, 47-63Hz, peak
60W, 30W average

Front Panel Controls and Indicators

Controls:	Record control to instantly start recording
Alarm Indicators (2):	Disk drive alarm, archive alarm
Level Indicators (4):	Analogue input level for each indicator

Additional Information

Audio Formats: MPEG layer 2, G.729A

Sample Rates: MPEG: 16kHz, 22.05kHz,
24kHz, 32kHz, 44.1kHz and 48kHz
G.729A: fixed at 8kHz

Recording Types: MPEG: Stereo, Dual Mono, Mono
G.729A: Dual Mono, Mono

Minimum PC Specification

Pentium 166MHz, 64MB RAM, Windows compatible Sound card (capable of playing PCM files) & speakers, 10Mbps network connection, Windows XP, 7, 8 or 10, DirectX 6 or greater.

Real Time Clock Accuracy: 1.53 minutes per month.

Hard Disk Capacity: A minimum hard-disk size of 1TB is fitted.
Due to the rapidly increase of disk capacities, the actual hard disk installed may be larger than this.

The following tables show the capacity in duration for the different record formats. If more than one channel is used then the duration will need to be shared.

MP2 Record Data Rates

MPEG Data Rate in kilobits per second (kbps)	Record Duration per Gigabyte of Hard Disk Space
8	11d 13h 46m
16	5d 18h 53m
24	3d 20h 35m
32	2d 21h 26m
40	2d 7h 33m
48	1d 22h 17m
56	1d 15h 40m
64	1d 10h 43m
80	1d 3h 46m
96	23h 8m
112	19h 50m
128	17h 22m
144	15h 25m
160	13h 53m
192	11h 34m
224	9h 55m
256	8h 41m
320	6h 56m
384	5h 47m

G.729A Data Rate in kilobits per second (kbps)	Record Duration per Gigabyte of Hard Disk Space
9.6 (fixed)	9d 15h 28m

MP3 Data Rates Supported For Play Download

The selectable mp3 bit rates for Play Download in Net-Log-Win are dependant on the sample rate of the original recording as follows:

Original Sample Rate:	Available Bit-Rates:
16kHz, 22kHz & 24kHz	32 kbps, 40 kbps, 48 kbps, 56 kbps, 64 kbps, 80 kbps, 96 kbps, 112 kbps, 128 kbps or 160 kbps
32kHz, 44.1kHz & 48kHz	32 kbps, 40 kbps, 48 kbps, 56 kbps, 64 kbps, 80 kbps, 96 kbps, 112 kbps, 128 kbps, 160 kbps, 192 kbps, 224 kbps, 256 kbps or 320kbps

Pin Connections

COM 1/2 (9 Pin D-Type Plug):			
Pin No.	Signal	Direction	Description
1	CD	I	Carrier Detect
2	Rx	I	Receive Data
3	Tx	O	Transmit Data
4	DTR	O	Data Terminal Ready
5	SG	-	Signal Ground
6	DSR	I	Data Set Ready
7	RTS	O	Request To Send
8	CTS	I	Clear To Send
9	N/C	-	No Connection

Network Connector (RJ45):			
Pin No.	Signal	Direction	Description
1	Tx+	O	Transmit Data (Positive)
2	Tx-	O	Transmit Data (Negative)
3	Rx+	I	Receive Data (Positive)
4	N/C	-	No Connection
5	N/C	-	No Connection
6	Rx-	I	Receive Data (Negative)
7	N/C	-	No Connection
8	N/C	-	No Connection

Network Connector (BNC Socket):			
Pin No.	Signal	Direction	Description
1	Rx	I	Receive Data
2	Tx	O	Transmit Data

Audio Inputs (XLR Socket):			
Pin No.	Signal	Direction	Description
1	S	-	Screen
2	P	I	Phase
3	NP	I	Non-Phase

Alarm Outputs/Remote Inputs And Outputs (15 Pin D-Type Plug):			
Pin No.	Signal	Direction	Description
1	Relay Common	O	Alarm Output Relay Common
2	Relay N/C	O	Alarm Output Relay N/C to Pin 1 activates for both Archive and Hard Disk Alarms
3	Relay N/O	O	Alarm Output Relay N/O to Pin 1 activates for both Archive and Hard Disk Alarms
4	Relay Common	O	Alarm Output Relay Common
5	Relay N/C	O	Alarm Output Relay N/C to Pin 4 activates for both Archive and Hard Disk Alarms
6	Relay N/O	O	Alarm Output Relay N/O to Pin 4 activates for both Archive and Hard Disk Alarms
7	GND	-	Ground
8	REMOTE_I1	I	Remote Input 1 short to Ground (Remote record Channel 1, Left input 1). Set to momentary or latching action via the Options, Record Remotes screen.

9	REMOTE_I2	I	Remote Input 2 short to Ground (Remote record Channel 2, Right input 1) Set to momentary or latching action via the Options, Record Remotes screen.
10	REMOTE_I3	I	Remote Input 3 short to Ground (Remote record Channel 3, Left input 2) Set to momentary or latching action via the Options, Record Remotes screen.
11	REMOTE_I4	I	Remote Input 4 short to Ground (Remote record Channel 4, Right input 2) Set to momentary or latching action via the Options, Record Remotes screen.
12	REMOTE_O1	O	Record Tally Output 1. Open collector driver (Channel 1, Left input 1)
13	REMOTE_O2	O	Record Tally Output 2. Open collector driver Channel 2, Right input 1)
14	REMOTE_O3	O	Record Tally Output 3. Open collector driver (Channel 3, Left input 2)

15	REMOTE_O4	O	Record Tally Output 4. Open collector driver (Channel 4, Right input 2)
----	-----------	---	---

15. Glossary

10Base2	Coaxial, Thin Ethernet. The 10 indicates a transfer rate of 10 Mbps. Base indicates a baseband medium and the 2 indicates that the sections must be a maximum of 200 meters.		
10BaseT	RJ45, Twisted Pair Ethernet. The 10 indicates a transfer rate of 10 Mbps Base indicates a baseband medium and the T indicates twisted pair wiring.		
Bit Rate	The raw speed of data over a serial link. Depending on the type of link this may indicate the theoretical maximum rates e.g. 10BaseT sends packets of data at 10Mbps but due to overheads and the availability the actual data throughput is significantly less. For audio data rates the bitrate is the actual amount of data generated per second		
Channel	Audio signal that generates a single audio stream. The signal can be either mono or stereo but will still be treated a single channel. If the Net-Log is formatted to use dual mono then this is considered as providing 2 channels. If both audio inputs are formatted as dual mono then a total of 4 channels will be available.		
Client	A node on the network that receives services from a server.		
Collision (CI)	This occurs when two different nodes attempt to use the network at the same time.		
Cut	A single continuous piece of audio, either stereo or mono, recorded on the hard drive		
		dB (decibel)	A ratio of two voltages or signal levels, expressed by the equation $\text{dB} = 20\text{LOG}(V1/V2)$ Adding the suffix "u" denotes that the signal is relative to 0.775V RMS Adding the suffix "v" denotes that the signal is relative to 1V RMS
		DHCP	Dynamic Host Configuration Protocol; Hosts are given configuration information across a network, usually from a server.
		DNS	Domain Name System; TCP/IP applications resolve a name into an IP Address
		G.729A	High compression record format primarily designed for speech.
		Gain	The degree of amplification, or attenuation, applied to a signal.
		Gateway	A router that links one network to another.
		Gigabyte or GB	1000 million bytes of data storage for a disk drive or 1073 million bytes of data storage for memory (i.e. 1024 x 1024 x 1024 bytes)
		Host ID	The part of the IP Address identifying the node within the network.
		Hub	A device used to connect nodes together to form a network.
		IP Address	Internet Protocol Address; A 32-bit address used to locate a node on a network.

kbps	Acronym for kilo (thousand) bits per second	THD	The Total Harmonic Distortion is the percentage presence of signals outside the measured frequency range.
LED	Light Emitting Diode.	Tx	Shorthand for Transmitter
Link	A connection to a network.	UTC	Acronym for Universal Time Code which is an internet reference time based on Greenwich Mean Time
Mbps	Acronym for Mega (million) bits per second	UTP	Acronym for Unshielded Twisted Pair which is the description of the type of cable normally used networking or phone connections
MPEG	Acronym for Motion Picture Experts Group who were responsible for the initial audio compression specification		
NetworkID	The part of the IP Address identifying the address of the local network.		
NIC	Network Interface Card; A card placed in a PC or Device used to connect to a network.		
Node	A device connected to a network, usually a PC or Printer.		
Octet	Eight bits. There are four octets in an IP Address.		
Rx	Shorthand for Receiver		
Sample Rate	The frequency at which the incoming audio is sampled. The higher the sample rate the higher the frequency of the audio that will be captured.		
Subnet Mask	A mask address to determine the NetworkID and HostID contained in an IP Address.		
Switch	An intelligent hub.		
TCP/IP	Transmission Control Protocol/Internet Protocol;		

SONIFEX

www.sonifex.co.uk

t:+44 (0)1933 650 700

f:+44 (0)1933 650 726

sales@sonifex.co.uk